

# SERVICE MANUAL

TECHNICAL INFORMATION  
FOR SERVICE PERSONNEL ONLY

## airHome 400

**ROOM AIR CONDITIONER**  
**SPLIT TYPE**  
**DJ SERIES**

### MODEL

RAK-DJ24PHAA

### CONTENTS

|  |          |
|--|----------|
| SPECIFICATIONS                           | Page 5   |
| HOW TO USE                               | Page 7   |
| CONSTRUCTION AND DIMENSIONAL DIAGRAM     | Page 39  |
| MAIN PARTS COMPONENT                     | Page 40  |
| WIRING DIAGRAM                           | Page 41  |
| PRINTED WIRING BOARD LOCATION DIAGRAM    | Page 44  |
| CIRCUIT DIAGRAM                          | Page 45  |
| BLOCK DIAGRAM                            | Page 47  |
| BASIC MODE                               | Page 49  |
| REFRIGERATING CYCLE DIAGRAM              | Page 69  |
| PROCEDURE FOR DISASSEMBLY AND REASSEMBLY | Page 70  |
| DESCRIPTION OF MAIN CIRCUIT OPERATION    | Page 72  |
| SERVICE CALL Q & A                       | Page 79  |
| PARTS LIST AND DIAGRAM                   | Page 106 |

# HITACHI

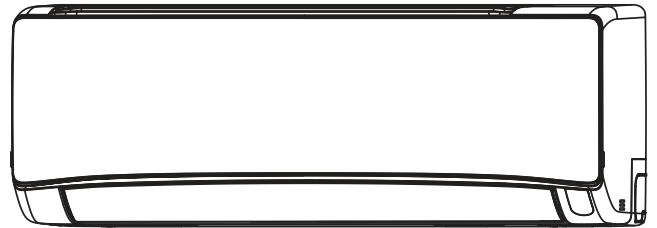

INDOOR UNIT  
RAK-DJ24PHAA

RC-AGU1EA0N

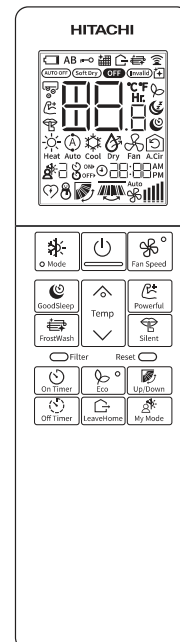

Cooling & Heating

# air

# SAFETY DURING REPAIR WORK

1. In order to disassemble and repair the unit in question, be sure to disconnect the power cord plug from the power outlet before starting the work.

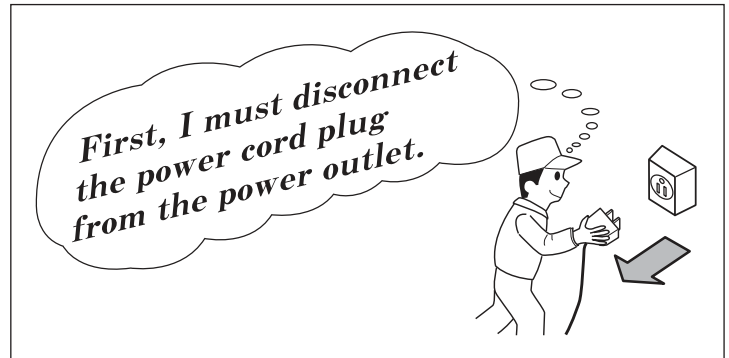

2. If it is necessary to replace any parts, they should be replaced with respective genuine parts for the unit, and the replacement must be effected in correct manner according to the instructions in the Service Manual of the unit.

If the contacts of electrical parts are defective, replace the electrical parts without trying to repair them.

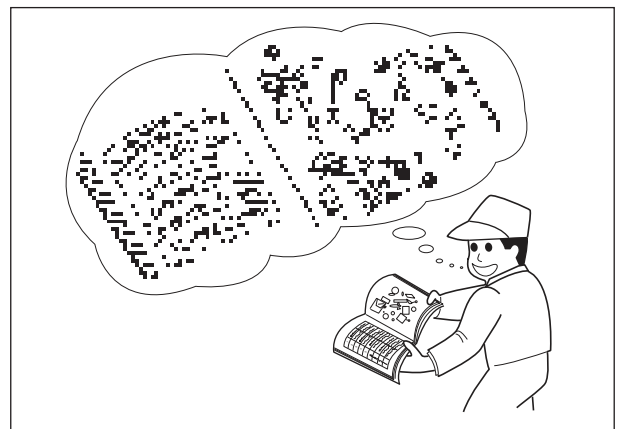

3. After completion of repairs, the initial state should be restored.
4. Lead wires should be connected and laid as in the initial state.
5. Modification of the unit by the user himself should absolutely be prohibited.
6. Tools and measuring instruments for use in repairs or inspection should be accurately calibrated in advance.
7. In installing the unit having been repaired, be careful to prevent the occurrence of any accident such as electrical shock, leak of current, or bodily injury due to the drop of any part.
8. To check the insulation of the unit, measure the insulation resistance between the power cord plug and grounding terminal of the unit. The insulation resistance should be  $1M\Omega$  or more as measured by a 500V DC megger.
9. The initial location of installation such as window, floor or the other should be checked for being and safe enough to support the repaired unit again. If it is found not so strong and safe, the unit should be installed at the initial location after reinforced or at a new location.
10. Any inflammable object must not be placed about the location of installation.
11. Check the grounding to see whether it is proper or not, and if it is found improper, connect the grounding terminal to the earth.



## WORKING STANDARDS FOR PREVENTING BREAKAGE OF SEMICONDUCTORS

### 1. Scope

The standards provide for items to be generally observed in carrying and handling semiconductors in relative manufacturers during maintenance and handling thereof. (They apply the same to handling of abnormal goods such as rejected goods being returned).

### 2. Object parts

- (1) Micro computer
- (2) Integrated circuits (I.C.)
- (3) Field-effective transistor (F.E.T.)
- (4) P.C. boards or the like to which the parts mentioned in (1) and (2) of this paragraph are equipped.

### 3. Items to be observed in handling

- (1) Use a conductive container for carrying and storing of parts. (Even rejected goods should be handled in the same way).

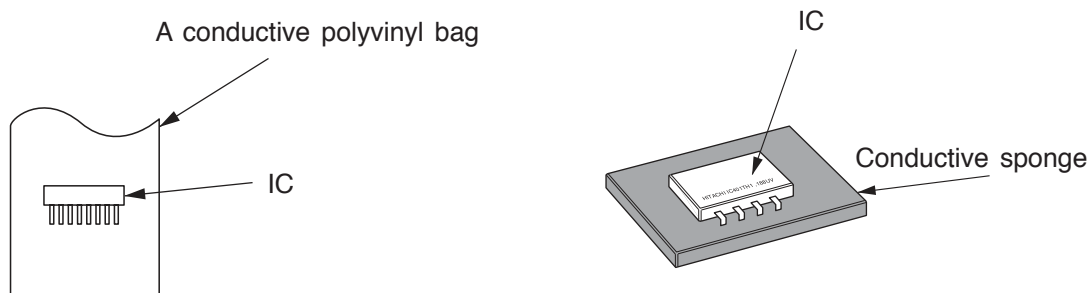

Fig. 1. Conductive container

- (2) When any part is handled uncovered (in counting, packing and the like), the handling person must always use himself as a body earth. (Make yourself a body earth by passing  $1M\Omega$  earth resistance through a ring or bracelet).
- (3) Be careful not to touch the parts with your clothing when you hold a part even if a body earth is being taken.
- (4) Be sure to place a part on a metal plate with grounding.
- (5) Be careful not to fail to turn off power when you repair the printed circuit board. At the same time, try to repair the printed circuit board on a grounded metal plate.

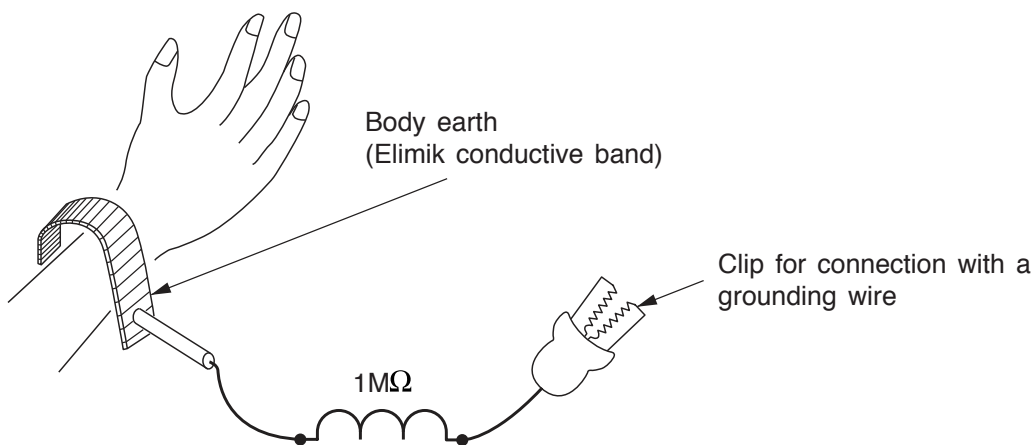

Fig. 2. Body Earth

(6) Use a three wire type soldering iron including a grounding wire.

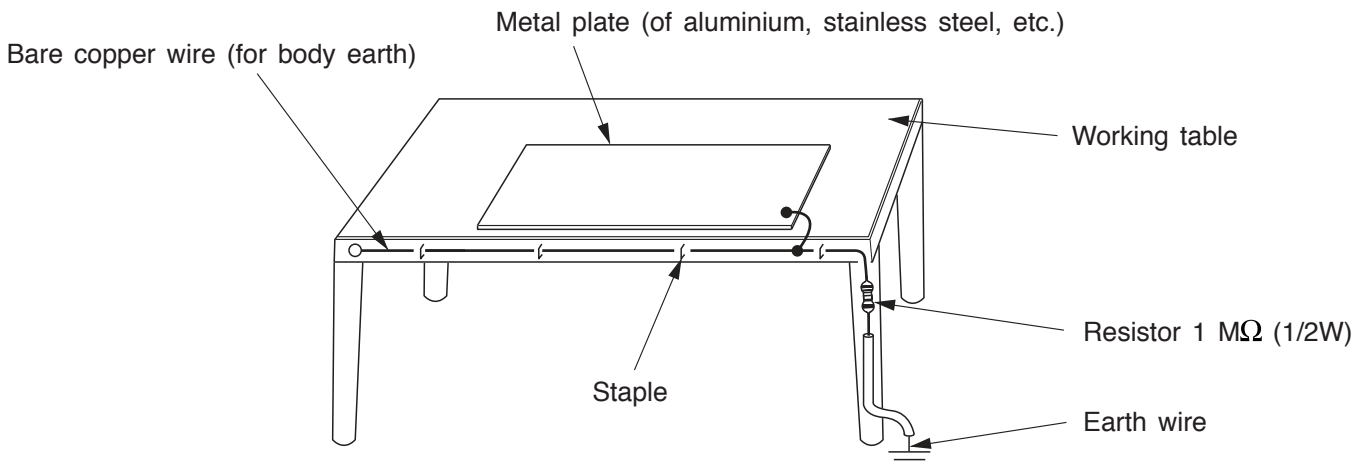

Fig. 3. Grounding of the working table

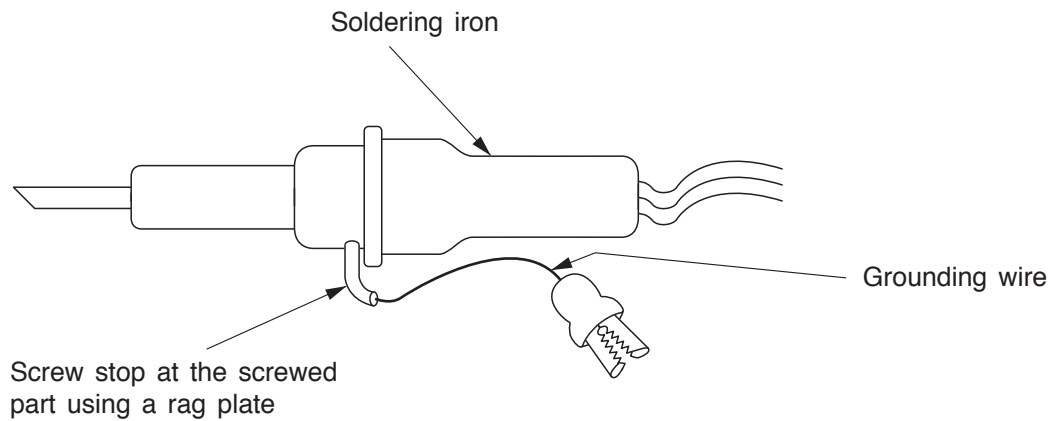

Fig. 4. Grounding a solder iron

Use a high insulation mode (100V, 10MΩ or higher) when ordinary iron is to be used.

(7) In checking circuits for maintenance, inspection or some others, be careful not to have the test probes of the measuring instrument short circuit a load circuit or the like.

**⚠ CAUTION**

1. In quiet or stop operation, slight flowing noise of refrigerant in the refrigerating cycle is heard occasionally, but this noise is not abnormal for the operation.
2. When it thunders nearby, it is recommend to stop the operation and to disconnect the power cord plug from the power outlet for safety.
3. In the event of power failure, the air conditioner will restart automatically in the previously selected mode once the power is restored. In the event of power failure during TIMER operation, the air conditioner will not start automatically. Re-press ON/OFF button after 3 minutes from when the unit off or power recovery.
4. If the room air conditioner is stopped by adjusting thermostat, or miss operation, and re-start in a moment, there is occasion that the cooling and heating operation does not start for 3 minutes, it is not abnormal and this is the result of the operation of IC delay circuit. This IC delay circuit ensures that there is no danger of blowing fuse or damaging parts even if operation is restarted accidentally.
5. This room air conditioner should not be used at the cooling operation when the outside temperature is below  $-10^{\circ}\text{C}$  ( $14^{\circ}\text{F}$ ).
6. This room air conditioner (the reverse cycle) should not be used when the outside temperature is below  $-15^{\circ}\text{C}$  ( $5^{\circ}\text{F}$ ).  
If the reverse cycle is used under this condition, the outside heat exchanger is frosted and efficiency falls.
7. When the outside heat exchanger is frosted, the frost is melted by operating the hot gas system, it is not trouble that at this time fan stops and the vapour may rise from the outside heat exchanger.

## SPECIFICATIONS

|                         |               |            |                          |
|-------------------------|---------------|------------|--------------------------|
| TYPE                    |               |            | DC INVERTER              |
|                         |               |            | INDOOR UNIT              |
| MODEL                   |               |            | RAK-DJ24PHAA             |
| POWER SOURCE            |               |            | 1PHASE, 60Hz, 208 ~ 230V |
| COOLING                 | TOTAL INPUT   | (W)        | 1,840 (950 - 2,390)      |
|                         | TOTAL AMPERES | (A)        | 8.889 (4.589 - 11.546)   |
|                         | CAPACITY      | (kW)       | 6.447 (2.40 - 7.09)      |
|                         |               | (B.T.U./h) | 21,998 (8,189 - 24.192)  |
| HEATING                 | TOTAL INPUT   | (W)        | 2,440 (690 - 2,980)      |
|                         | TOTAL AMPERES | (A)        | 11.787 (3.33 - 14.40)    |
|                         | CAPACITY      | (kW)       | 17.327 (2.43 - 8.05)     |
|                         |               | (B.T.U./h) | 59,122 (8,291 - 27,467)  |
| DIMENSIONS<br>inch (mm) |               | W          | 37-13/32" (950)          |
|                         |               | H          | 11-18/32" (294)          |
|                         |               | D          | 9-2/32" (230)            |
| NET WEIGHT              |               | lbs (kg)   | 26.45 (12)               |

※ After installation

|  |       |  |
|--|-------|--|
| MODEL                                  |       | RAK-DJ24PHAA                                       |
| FAN MOTOR                              |       | 38W  |
| FAN MOTOR CAPACITOR                    |       | NO   |
| FAN MOTOR PROTECTOR                    |       | NO   |
| COMPRESSOR                             |       | -  |
| COMPRESSOR MOTOR CAPACITOR             |       | NO   |
| OVERLOAD PROTECTOR                     |       | NO   |
| OVERHEAT PROTECTOR                     |       | NO   |
| FUSE (for MICROPROCESSOR)              |       | TSC3   |
| POWER RELAY                            |       | NO   |
| POWER SWITCH                           |       | NO   |
| TEMPORARY SWITCH                       |       | YES  |
| SERVICE SWITCH                         |       | NO   |
| TRANSFORMER                            |       | YES  |
| VARISTOR                               |       | B72214S2321K591V87                                 |
| NOISE SUPPRESSOR                       |       | NO   |
| THERMOSTAT                             |       | YES(IC)  |
| REMOTE CONTROL SWITCH (LIQUID CRYSTAL) |       | YES  |
| REFRIGERANT CHARGING VOLUME            | PIPES | WITHOUT REFRIGERANT BECAUSE COUPLING IS FLARE TYPE |

# Figure showing the Installation of Indoor Unit

MODEL RAK-DJ24PHAA

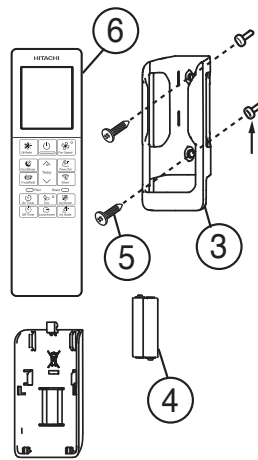
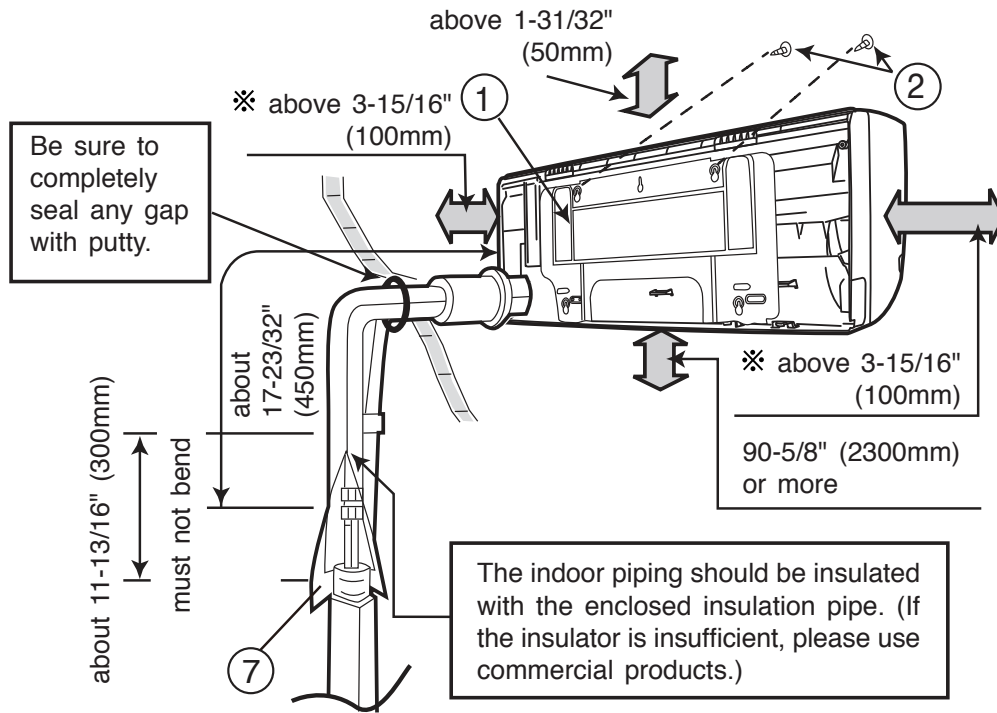

## Important Notice

---

- Johnson Controls-Hitachi Air Conditioning North America LLC pursues a policy of continuing improvement in design and performance in its products. As such, Johnson Controls-Hitachi Air Conditioning North America LLC reserves the right to make changes at any time without prior notice.
- Johnson Controls-Hitachi Air Conditioning North America LLC cannot anticipate every possible circumstance that might involve a potential hazard.
- This inverter air conditioning unit is designed for standard air conditioning applications only. Do not use this unit for anything other than the purposes for which it was intended.
- The installer and system specialist shall safeguard against leakage in accordance with local codes. The following standards may be applicable, if local regulations are not available. International Organization for Standardization: (ISO 5149 or European Standard, EN 378). No part of this manual may be reproduced in any way without the expressed written consent of Johnson Controls-Hitachi Air Conditioning North America LLC.
- This air conditioning unit will be operated and serviced in the United States of America and comes with a full complement of the appropriate Safety, Danger, and Caution, Warnings.
- If you have questions, please contact your distributor or contractor.
- This manual provides common descriptions, basic and advanced information to maintain and service this air conditioning unit which you operate as well for other models.
- This air conditioning unit has been designed for a specific temperature range. For optimum performance and long life, operate this unit within the range limits.
- This manual should be considered as a permanent part of the air conditioning equipment and should remain with the air conditioning equipment.

## Product Inspection upon Arrival

---

1. Upon receiving this product, inspect it for any damages incurred in transit. Claims for damage, either apparent or concealed, should be filed immediately with the shipping company.
2. Check the model number, electrical characteristics (power supply, voltage, and frequency rating), and any accessories to determine if they agree with the purchase order.
3. The standard utilization for this unit is explained in these instructions. Use of this equipment for purposes other than what it designed for is not recommended.
4. Please contact your local agent or contractor as any issues involving installation, performance, or maintenance arise. Liability does not cover defects originating from unauthorized modifications performed by a customer without the written consent of Johnson Controls-Hitachi Air Conditioning North America LLC. Performing any mechanical alterations on this product without the consent of the manufacturer will render your warranty null and void.

### California Proposition 65



**WARNING**



*Proposition 65: This product contains chemicals known to the state of California to cause cancer, birth defects, and other reproductive harm. For more information, go to [www.P65Warnings.ca.gov](http://www.P65Warnings.ca.gov)*









# SAFETY PRECAUTION





- Please read the "Safety Precaution" carefully before operating the unit to ensure correct usage of the unit.
- Pay special attention to signs of "▲ Warning" and "▲ Caution". The "Warning" section contains matters which, if not observed strictly, may cause death or serious injury. The "Caution" section contains matters which may result in serious consequences if not observed properly. Please observe all instructions strictly to ensure safety.
- The sign indicate the following meanings.

|   |   |
|---|---|
|  Make sure to connect earth line.                  |  The sign in the figure indicates prohibition. |
|  Indicates the instructions that must be followed. |   |



|   |   |   |   |
|---|---|---|---|
| <br>Refrigerant Safety Group A2L<br><b>WARNING</b> | This appliance is filled with R32.  | <br><b>CAUTION</b> | This symbol shows that a service personnel should be handling this equipment with reference to the Installation Manual. |
| <br><b>CAUTION</b>                                 | This symbol shows that the Operation Instructions should be read carefully. | <br><b>CAUTION</b> | This symbol shows that there is information included in the Operation Manual and/or Installation Manual                 |

- Please keep this manual after reading.







## PRECAUTIONS DURING INSTALLATION

|   |   |
|---|---|
| <br><b>WARNING</b>   | <ul style="list-style-type: none"> <li>• Do not reconstruct the unit. Water leakage, fault, short circuit or fire may occur if you reconstruct the unit by yourself. </li> <li>• Please ask your sales agent or qualified technician for the installation of your unit. Water leakage, short circuit or fire may occur if you install the unit by yourself.</li> </ul>   |
|   | <ul style="list-style-type: none"> <li>• Please use earth line. Do not place the earth line near water or gas pipes, lightning-conductor, or the earth line of telephone. Improper installation of earth line may cause electric shock. </li> <li>• Be sure to use the specified piping set for R32. Otherwise, this may result in broken copper pipes or faults.</li> <li>• Do not use refrigerant other than the one indicated on the outdoor unit (R32) when installing, moving or repairing. Using other refrigerants may cause trouble or damage to the unit, and personal injury.</li> </ul>   |
| <br><b>CAUTION</b> | <ul style="list-style-type: none"> <li>• A circuit breaker should be installed depending on the mounting site of the unit. Without a circuit breaker, the danger of electric shock exists.</li> <li>• Do not install near location where there is flammable gas. The outdoor unit may catch fire if flammable gas leaks around it. </li> <li>• Please ensure smooth flow of water when installing the drain hose.</li> <li>• Do not install the indoor unit in a machine shop, kitchen and laundry rooms when vapor from oil or its mist flows to the indoor unit. The oil will deposit on the heat exchanger, thereby reducing the indoor unit performance and may deform and in the worst case, break the plastic parts of the indoor unit.</li> </ul> |

## PRECAUTIONS DURING SHIFTING OR MAINTENANCE

|   |  |
|---|--|
| <br><b>W<br/>A<br/>R<br/>N<br/>I<br/>N<br/>G</b> | <ul style="list-style-type: none"> <li>• Should abnormal situation arises (like burning smell), please stop operating the unit and turn off the circuit breaker. Contact your agent. Fault, short circuit or fire may occur if you continue to operate the unit under abnormal situation. </li> </ul>   |
|   | <ul style="list-style-type: none"> <li>• Please contact your agent for maintenance. Improper self maintenance may cause electric shock and fire.</li> </ul>  |
|   | <ul style="list-style-type: none"> <li>• Please contact your agent if you need to remove and reinstall the unit. Electric shock or fire may occur if you remove and reinstall the unit yourself improperly.</li> </ul>   |
|   | <ul style="list-style-type: none"> <li>• If the supply cord is damaged, it must be replaced by the special cord obtainable at authorized service/parts centers.</li> </ul>   |
|   | <ul style="list-style-type: none"> <li>• If the air conditioner is not cool, one possible cause could be due to refrigerant leakage, so consult your dealer. The refrigerant gas used in the air conditioner is harmless. But if refrigerant gas leaks into the room, harmful products are generated when in contact with fire from appliances such as a stove heater. When there is refrigerant gas accumulation in the room, immediately stop the air conditioner. Open the windows for ventilation and contact your agent.</li> </ul> |

## PRECAUTIONS DURING OPERATION

|   |   |
|---|---|
| <br><b>W<br/>A<br/>R<br/>N<br/>I<br/>N<br/>G</b> | <ul style="list-style-type: none"> <li>• Avoid an extended period of direct air flow for your health. </li> </ul>  |
|   | <ul style="list-style-type: none"> <li>• Do not insert a finger, a rod or other objects into the air outlet or inlet. As the fan is rotating at a high speed, it will cause injury. Before cleaning, be sure to stop the operation and turn the breaker OFF. </li> </ul> |
|   | <ul style="list-style-type: none"> <li>• Do not use any conductor as fuse wire, this could cause fatal accident. </li> </ul>   |
|   | <ul style="list-style-type: none"> <li>• During thunder storm, disconnect and turn off the circuit breaker. </li> </ul>  |
|   | <ul style="list-style-type: none"> <li>• Spray cans and other combustibles should not be located within a meter of the air outlets of both indoor and outdoor units. As a spray can's internal pressure can be increased by hot air, a rupture may result. </li> </ul> |

## PRECAUTIONS DURING OPERATION

- The product shall be operated under the manufacturer specification and not for any other intended use.

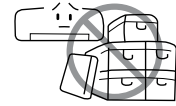

- Do not attempt to operate the unit with wet hands, this could cause fatal accident.

- When operating the unit with burning equipments, regularly ventilate the room to avoid oxygen insufficiency.

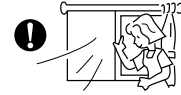

- Do not direct the cool air coming out from the air-conditioner panel to face household heating apparatus as this may affect the working of apparatus such as the electric kettle, oven etc.

- Please ensure that outdoor mounting frame is always stable, firm and without defect. If not, the outdoor unit may collapse and cause danger.



- Do not splash or direct water to the body of the unit when cleaning it as this may cause short circuit.

- Do not use any aerosol or hair sprays near the indoor unit. This chemical can adhere on heat exchanger fin and blocked the evaporation water flow to drain pan. The water will drop on tangential fan and cause water splashing out from indoor unit.



- Please switch off the unit and turn off the circuit breaker during cleaning, the high-speed fan inside the unit may cause danger.



- Turn off the circuit breaker if the unit is not to be operated for a long period.



- Do not climb on the outdoor unit or put objects on it.

- Do not put water container (like vase) on the indoor unit to avoid water dripping into the unit. Dripping water will damage the insulator inside the unit and causes short-circuit.

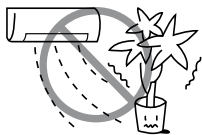
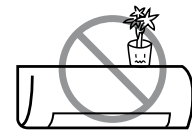

- Do not place plants directly under the air flow as it is bad for the plants.

- When operating the unit with the door and windows opened, (the room humidity is always above 80%) and with the air deflector facing down or moving automatically for a long period of time, water will condense on the air deflector and drips down occasionally. This will wet your furniture. Therefore, do not operate under such condition for a long time.

- If the amount of heat in the room is above the cooling or heating capability of the unit (for example: more people entering the room, using heating equipments and etc.), the preset room temperature cannot be achieved.

- This appliance can be used by children aged from 8 years and above and persons with reduced physical, sensory or mental capabilities or lack of experience and knowledge if they have been given supervision or instruction concerning use of the appliance in a safe way and understand the hazards involved. Children shall not play with the appliance. Cleaning and user maintenance shall not be made by children without supervision.



C  
A  
U  
T  
I  
O  
N

**Operation Range**

|                     |                                  |                                  |
|---------------------|----------------------------------|----------------------------------|
| Operation mode      | Cooling/Dehumidifying            | Heating                          |
| Outdoor temperature | -0.4°F (-18°C) to 114.8°F (46°C) | -5°F (-20.55°C) to 75.2°F (24°C) |

**Names and Functions of Each Part**

**Indoor Unit**

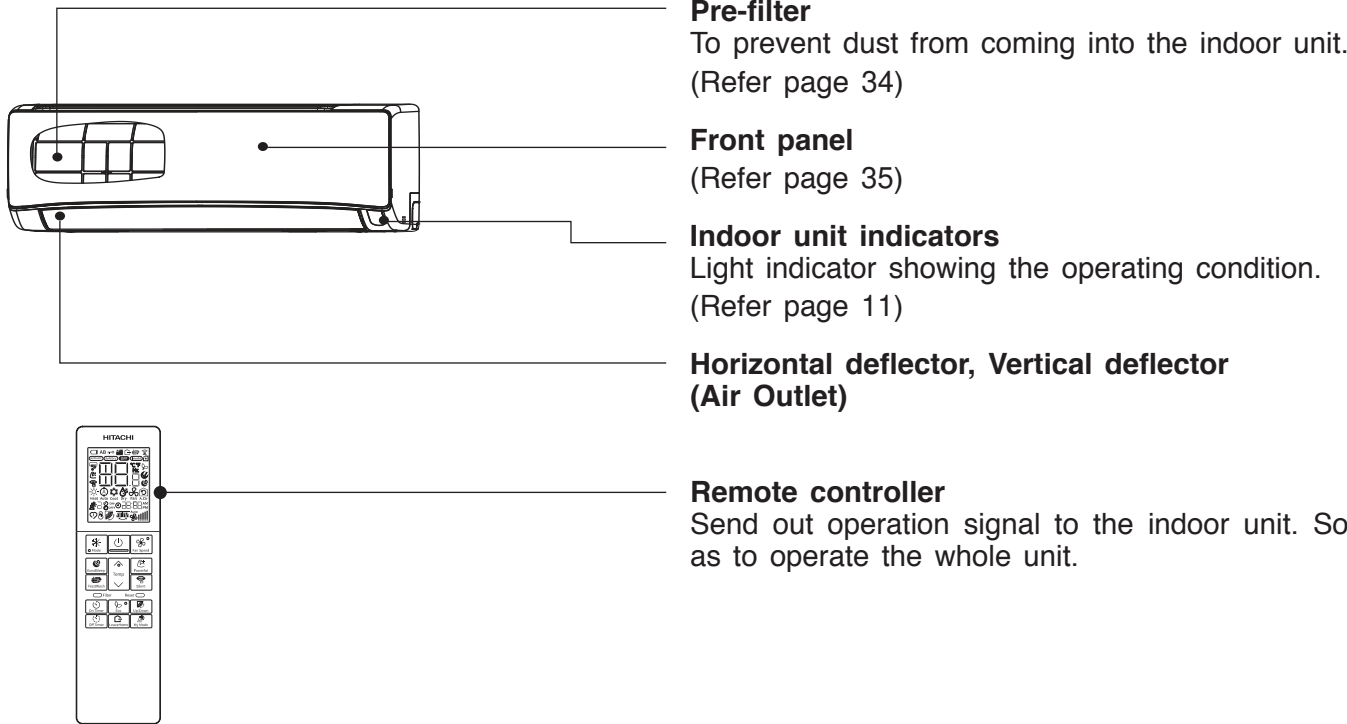

**Model Name and Dimensions**

| MODEL        | WIDTH in(mm)     | HEIGHT in(mm)   | DEPTH in(mm)   |
|--------------|------------------|-----------------|----------------|
| RAK-DJ24PHAA | 41-11/32" (1050) | 11-18/32" (294) | 9-27/32" (250) |

# NAMES AND FUNCTIONS OF EACH PART

## INDOOR UNIT INDICATIONS

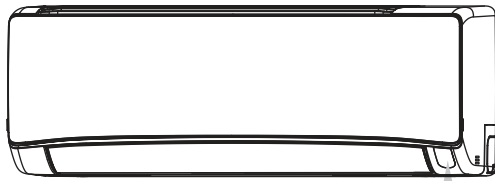

### Operation Lamp (Yellow)

This lamp lights during operation.

### Timer Lamp (Orange)

This lamp lights when the timer is working.

### Wi-Fi Lamp (Blue)

Optional

### Clean Function Lamp (Green)

This lamp uses for FrostWash, Mold Guard, Filter Sign.

### Temporary Switch

Use this switch to start and stop when the remote controller does not work.

- By pressing the temporary switch, the operation is done in automatic mode.
- When the operation is done using the temporary switch after the power source is turned off and turn on again, the operation is done in automatic mode.

### ⚠ CAUTION

Turn off the circuit breaker if the unit is not be operated for a long period.

☆ If the power stays on and the unit is not operated, power is slightly consumed in the control circuit. The power is saved by turning off the power switch (or the circuit breaker when the power is supplied from the outdoor unit).

## INFORMATION

### Capabilities

#### CAUTION

Do not use a stove or any other high temperature devices in proximity to the indoor unit.



PROHIBITION

### Cooling and Dehumidifying Capabilities

- If the heat present in a room exceeds the unit's cooling capacity (for example, if there are many people in the room or other heating appliances are used), the preset room temperature may not be reached.

### Refrigerant Information

- For the refrigerant charge information, please refer to the outdoor unit installation manual or specification label.

# Names and Functions of Remote Controller

■ This remote controller controls the operation function and timer setting of the room air conditioner. The operating range of the remote controller is about 23 feet. If indoor lighting is controlled electronically, the range of control may be shorter.

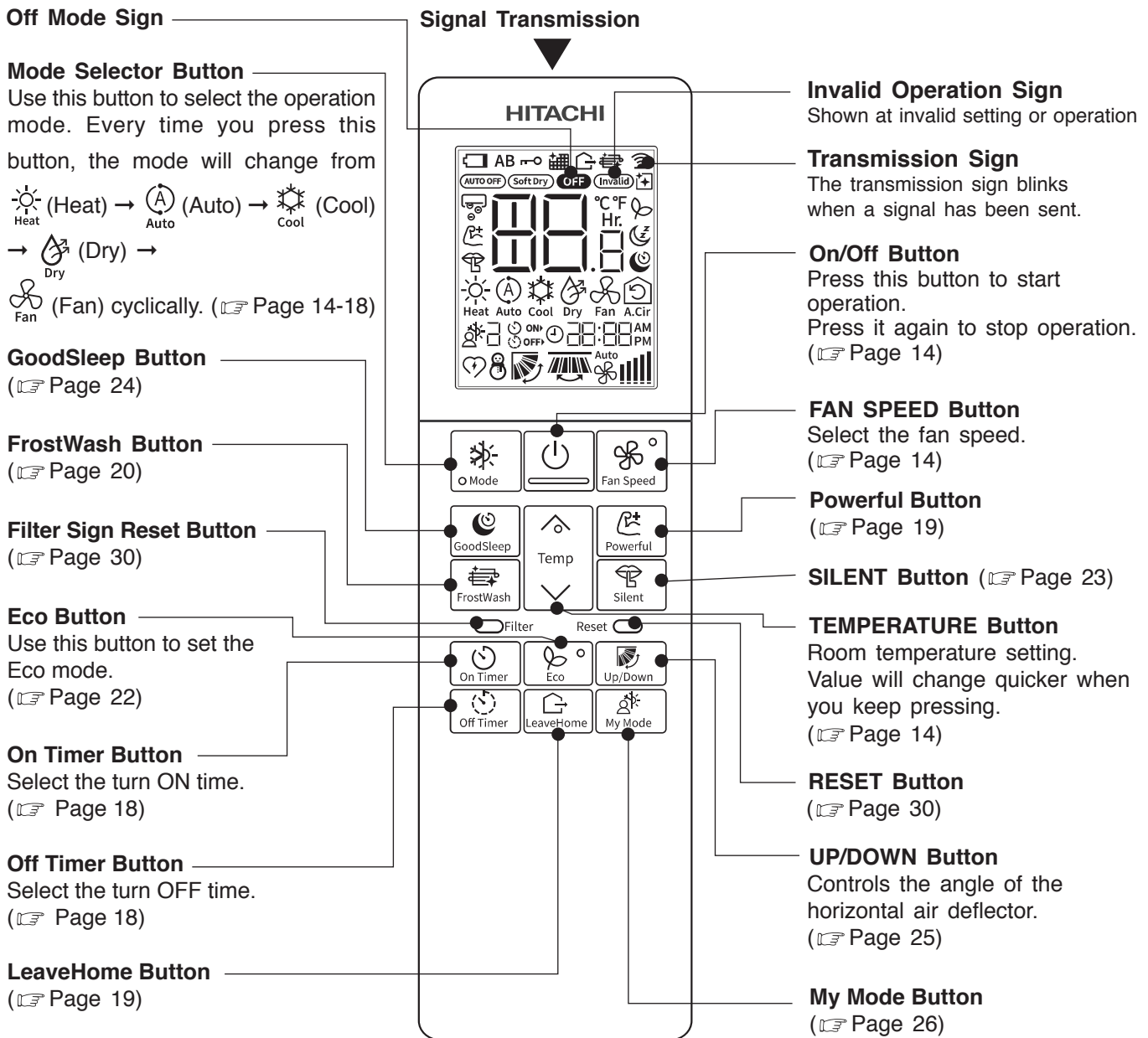

## Backlight function

- Backlight is to see the LCD readings in the dark.
- On pressing any key, the LCD panel lights up for a period of approx. 10 seconds. After approx. 10 seconds the light automatically switches off.
- The function is independent of all other functions of the air conditioner.
- The backlight color is white.

## Precautions for Use

- Do not put the remote controller under direct sunlight and high temperature.
- Do not drop it on the floor, and protect it from water.
- If you press the Mode button during operation, the air conditioner may stop for about 3 minutes for protection before you can start it again.

# How to Install the Batteries in the Remote Controller

**1** Remove the cover as shown in the figure and take out the old batteries.



**2** Install the new batteries. The direction of the batteries should match the marks in the case.

## CAUTION





1. Do not use new and old batteries, or different kinds of batteries together.
2. Take out the batteries when you do not use the remote controller for 2 or 3 months.

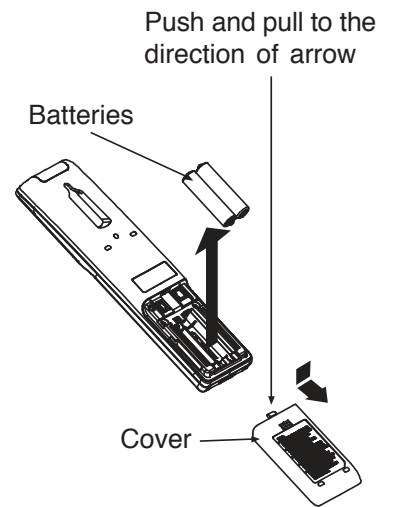

## NOTE



- Change the batteries when remote controller LCD display restarts on pressing of any key and there is no response from air conditioner.



# How to set clock

**1** Press the Hold Timer ON button  or Timer OFF button  for 5 seconds.  ON or  OFF segment start blinking on LCD approx. 5 seconds then Clock  symbol start blinking.

**2** When Clock  symbol is in blinking, press Temperature Up/Down  button to change/set desire time value.

**3** Press Timer ON button  or Timer OFF button  once. Clock  symbol stop blinking and Clock time will be display on LCD screen.

## NOTE

- When Timer ON, Timer OFF or both set then it is not possible to change/set clock time. First Timer ON, Timer OFF or both need to cancel.
- If Correct clock time is not set then Timer ON and Timer OFF will not operate correctly.
- At time of Battery replacement/Reset, Clock time need to set. If it is not set and press any key then default 12:00 will be set.
- At time of Battery replacement / Reset, need to follow process from step 2 onwards.
- During Clock time change/set when  symbol is blinking, if no key press then it will come out of Clock setting with previous set time.

# VARIOUS FUNCTIONS

## Auto Restart Control

- If there is a power failure, operation will be automatically restarted when the power is resumed with previous operation mode and airflow direction.  
(As the operation is not stopped by remote controller.)
- If you intend not to continue the operation when the power is resumed, switch off the power supply. When you switch on the circuit breaker, the operation will be automatically restarted with previous operation mode and airflow direction.  
Note: 1. If you do not require Auto Restart Control, please consult your sales agent.  
2. Auto Restart Control is not available when Timer or GoodSleep Timer is set.

## Auto Mode



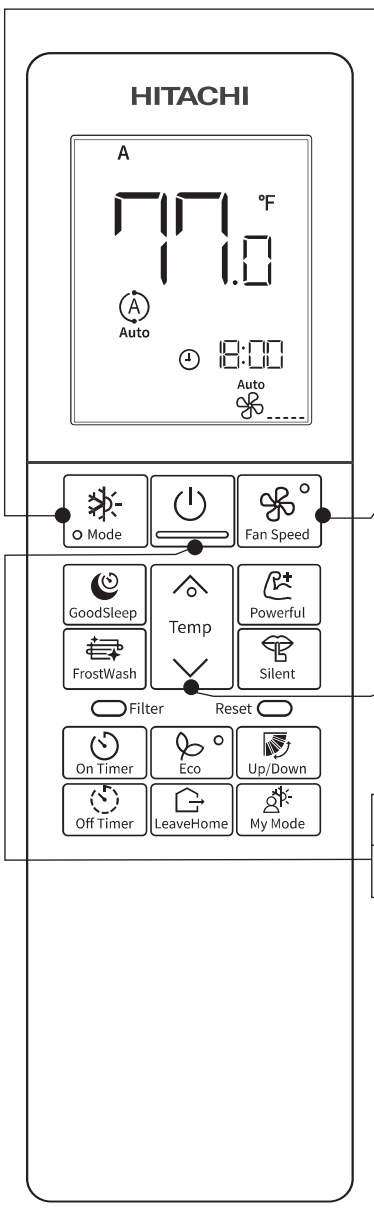



The device will automatically determine the mode of operation, Heat Mode or Cool Mode depending on the current room temperature. The selected mode of operation will change when the room temperature varies.



**1** Press the Mode Selector Button so that the display indicates the  (Auto) mode of operation.

- When Auto has been selected, the device will automatically determine the mode of operation, Heat or Cool depending on the current room temperature.
- If the mode automatically selected by the unit is not satisfactory, manually change the mode setting (Heat, Dry, Cool or Fan).

**2** Set the desired Fan Speed with the  (Fan Speed) button. (the display indicates the setting).

Auto  (Auto) →  (Silent) →  (Low) →  (Medium) →  (High) →  (Super High)

**3** Set the desired room temperature with the Temperature buttons. (the display indicates the setting).  
The temperature setting and the actual room temperature may vary depending on conditions.  
Temperature range can be set between 60°F and 90°F.

**START** Press the  (On/Off) button.  
**STOP** Operation starts with a beep.  
Press the button again to stop operation.

■ As the settings are stored in the memory of the remote controller, you only have to press the  (On/Off) button next time.

Press the  (Fan Speed) button to select Auto, Silent, Low, Medium, High or Super High.

# Heat Mode

- Use the device for heating when the outdoor temperature is under 75.2°F. When it is too warm (over 75.2°F), the heating function may not work in order to protect the device.
- In order to keep reliability of the device, please use this device above -5°F of the outdoor temperature.

**1** Press the Mode Selector Button so that the display indicates (Heat).

**2** Set the desired Fan Speed with the (Fan Speed) button. (the display indicates the setting).

Auto → → → → → → → → → → (Auto)

**3** Set the desired room temperature with the Temperature buttons (the display indicates the setting). The temperature setting and the actual room temperature may vary depending on conditions. Temperature range can be set between 60°F and 90°F.

**START** Press the (On/Off) button. Heating operation starts with a beep. Press the button again to stop operation.

**STOP**

- As the settings are stored in the memory of the remote controller, you only have to press the (On/Off) button next time.
- During AUTO fan, the fan speed automatically changes as below:
  - When the difference between room temperature and setting temperature is large, fan starts to run at Super High speed.
  - After room temperature reaches the preset temperature, fan speed will be changed to lower speed to obtain optimum room temperature condition for natural healthy heating.

## ■ Defrosting

Defrosting will be performed about once an hour when frost forms on the heat exchange of the outdoor unit, for 5~10 minutes each time.

During defrosting operation, the operation lamp blinks in a cycle of 2 seconds on and 1 second off. The maximum time for defrosting is 20 minutes.

(If the piping length used is longer than usual, frost is likely to form.)



# Dry Mode

Use the device for dehumidifying when the room temperature is over 60°F.  
When it is under 59°F, the dehumidifying function does not work.

**1** Press the Mode Selector button so that the display indicates (Dry).  
The fan speed is set at Auto.  
Press (Fan Speed) button to select Silent, Low or Auto fan speed.

**2** Set the desired room temperature with the Temperature buttons. (the display indicates the setting).  
 The range 68°F to 79°F is recommended as the room temperature for dehumidifying.  
Temperature range can be set between 60°F and 90°F.

**START** Press the (On/Off) button. Dehumidifying operation starts with a beep. Press the button again to stop operation.

**STOP**

■ As the settings are stored in the memory of the remote controller, you only have to press the (On/Off) button next time.

## ■ Dehumidifying Function







- When the room temperature is higher than the set temperature, the device dehumidifies the room, reducing the room temperature to the preset level.  
When the room temperature is lower than the set temperature setting: Dehumidifying will be performed at the temperature setting slightly lower than the current room temperature, regardless of the temperature setting.
- The preset room temperature may not be reached depending on the number of people present in the room or other room conditions.

# Cool Mode



Use the device for cooling when the outdoor temperature is  $-0.4^{\circ}\text{F}$  to  $114.8^{\circ}\text{F}$ .  
 If indoors humidity is very high (over 80%), some dew may form on the air outlet grille of the indoor unit.

**1** Press the Mode Selector Button so that the display indicates (Cool). 

**2** Set the desired Fan Speed with the  (Fan Speed) button. (the display indicates the setting).

Auto  (Auto) →  (Silent) →  (Low) →  (Super High) ←  (High) ←  (Medium) ←

**3** Set the desired room temperature with the Temperature buttons. (the display indicates the setting).  
 The temperature setting and the actual room temperature may vary depending on conditions.  
 Temperature range can be set between  $60^{\circ}\text{F}$  and  $90^{\circ}\text{F}$ .

Press the  (On/Off) button. Cooling operation starts with a beep. Press the button again to stop operation. The cooling function does not start if the temperature setting is higher than the current room temperature (even though the  (Operation) lamp lights). The cooling function will start as soon as you set the temperature below the current room temperature.

**START STOP**



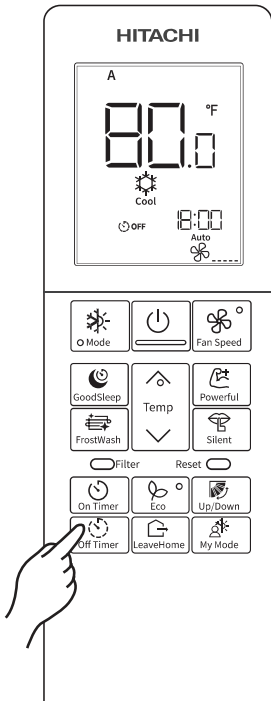

- As the settings are stored in the memory of the remote controller, you only have to press the  (On/Off) button next time.
- During AUTO fan, the fan speed automatically changes as below:
  - When the difference between room temperature and setting temperature is large, fan starts to run at Super High speed.
  - After room temperature reaches the preset temperature, fan speed will be changed to lower speed to obtain optimum room temperature condition for natural healthy cooling.

# Timer Reservation



## 1. Off Timer Setting





The device can be set to turn off at a preset time.

- Press  (Timer OFF) button to select OFF timer.
-  OFF Symbol start blinking and 12:00 or previously set time will be display on LCD screen.
- Set up desire Turn off time by pressing Temperature Up/Down button .
- After setting, point the remote controller towards the indoor unit and press  button.  
 OFF Symbol stop blinking and turn off time will be display on LCD screen.  
 A beep sound emitted from indoor unit and Timer LED on the indoor unit lights up.  
 Remote controller will go to OFF mode after OFF timer elapse.
- By pressing On Timer and Off Timer button together for 3 seconds, Off Timer can be canceled.

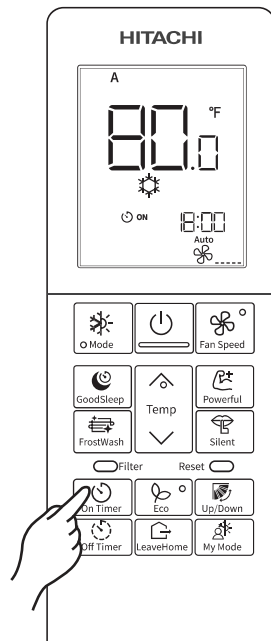

## 2. On Timer Setting

Indoor unit can be set to turn on at a preset time.



- Press  (Timer ON) button to select ON timer.
-  ON Symbol start blinking and 12:00 or previously set time will be display on LCD screen.
- Set up desire Turn on time by pressing Temperature Up/Down button .
- After setting, point the remote controller towards the indoor unit and press  button.  
 ON Symbol stop blinking and turn on time will be display on LCD screen.  
 A beep sound emitted from indoor unit and Timer LED on the indoor unit lights up.  
 Remote controller will go to ON mode after ON timer elapse.
- By pressing On Timer and Off Timer button together for 3 seconds, On Timer can be canceled.

### NOTE

- During the Timer Setting, if you do not press the Temperature Up/Down key within 10 seconds then it will come out of the Timer Setting without any changes in Timer Settings and will display with  OFF or  ON Icon will be stable appear on LCD to indicate Timer Setting if set previously.
- During Timer setting mode, if you press any key then it will come out immediately from timer setting.
- Timer On and Timer Off can be set simultaneously.
- When both timer set simultaneously then  on LCD appear with Timer which will going to execute/expire first.
- During Timer ON or Timer OFF set then Clock setting can not be changed. Clock time will not be display on LCD screen.
- Clock time can be seen on LCD screen by Press & Hold Timer ON or Timer OFF key for 5 seconds. Clock time display for 10 seconds then it will change to Timer ON or Timer OFF time value.

## Powerful Operation

- By pressing  (Powerful) button during Auto, Heat, Dry, Cool or Fan operation, the air conditioner performs at maximum power.
- During Powerful operation, cooler or warmer air will be blown out from indoor unit for Cooling or Heating operation respectively.

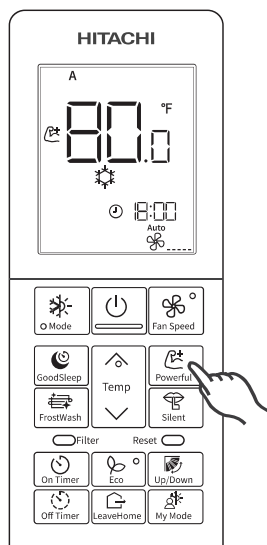



**START**

Press the  (Powerful) button during operation.

- “” is displayed on the LCD.  
Powerful operation ends in 20 minutes. Then, the system automatically operates with the previous settings used before Powerful operation.

**CANCEL**

- Press the  (On/Off) button or
- Press the  (Powerful) button again.  
“” disappears from the LCD.

### NOTE

- When Eco Operation, LeaveHome Operation, Silent Mode, GoodSleep Timer or My mode is selected, Powerful Operation will be cancelled.
- During Powerful operation, capacity of the air conditioner will not increase
  - if the air conditioner is already running at maximum capacity.
  - just before defrost operation (when the air conditioner is running in Heating operation).

## LeaveHome Operation

- Prevent the room temperature from falling too much when no one is at home. The initial setting temperature is 50°F and the temperature range can be set between 50°F to 60°F (Selected temperature is 50°F, 52°F, 54°F, 56°F, 58°F, 59°F and 60°F).

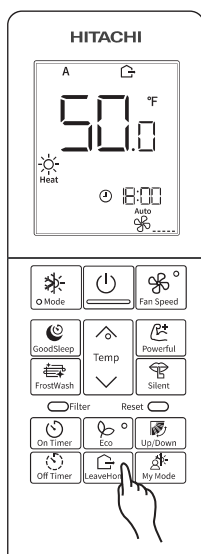



**START**

- ① Press  (LeaveHome) button during stop or operation.  
Room temperature is set at 50°F and heating operation starts.

- ② Set the desired room temperature with the Temperature buttons.  
Temperature range can be set between 50°F and 60°F.

“”, “”, “”, “Set Temperature” is displayed on the LCD.

**CANCEL**

- Press  (ON/OFF) button.
- Press  (LeaveHome) button again.  
Change the other Operation Mode.

### NOTE

- During LeaveHome operation, fan speed and horizontal air deflector position cannot be changed.

# FrostWash Operation

- The dust and dirt adhering to indoor heat exchanger which is the cause of the smell. They are washed away by freezing and thawing of the heat exchanger.
- FrostWash operation can work when the outdoor temperature is 34°F and 109°F and indoor humidity is 30% to 70%.

## The process of FrostWash

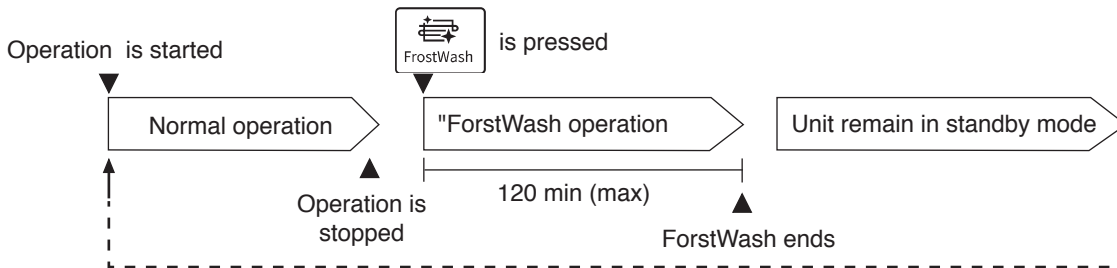





- “” lamp on the indoor unit lights up during FrostWash operation.
- When pressing “On/Off” button during FrostWash operation, FrostWash will stop.
- In order to protect the product, FrostWash function cannot be carried out again for about 60 minutes after FrostWash operation is completed.

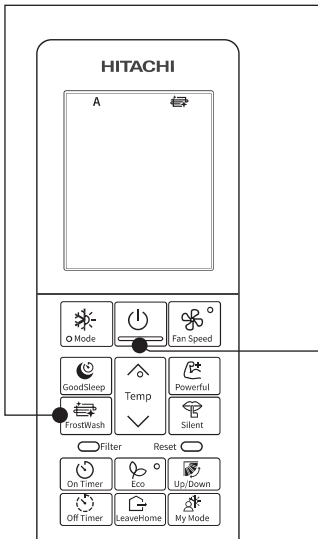

## ■ FrostWash(Manual Mode)

When the unit is off, press  (FrostWash) button, manual FrostWash will start.

## ■ How to start and cancel FrostWash (Manual mode)



- Press the FrostWash button , FrostWash  display on LCD screen. FrostWash operation start with beep sound and “” lamp light up on the indoor unit.
- After one hour, “” disappears from the LCD. After about two hours, the indoor unit will stop FrostWash operation.
- In order to protect the product, FrostWash function cannot be carried out again for about 60 minutes after the FrostWash operation is completed.

- Press the  (On/Off) button, the operation will stop. “” lamp on the indoor unit turns off.

## Precautions for Use

- Do not open windows or doors during FrostWash operation. Water will condense on the air deflector and drips down occasionally. This will wet your furniture.
- Do not open or remove the front panel during FrostWash operation. It may cause injury or malfunction.
- FrostWash operation does not wash away all dust and dirt.
- Hissing, fizzy or squeaking noise may generate during FrostWash operation.
- If the air conditioner is continuously running, FrostWash function is not effective.
- During FrostWash operation, if power is turned off and then power is restored, FrostWash function will not restart.
- After turning on the power, please wait a moment if you want to start FrostWash.
- If On Timer or Off Timer is set, there is a need to cancel those timer before operating FrostWash.

# Mold Guard Operation

- After the cooling operation is stopped, the fan of the indoor unit is dried by heating or fan mode to suppress the generation of mold inside the indoor unit.
  - Mold Guard Operation period is about 80 minutes.
  - It can't remove mold or sterilize.

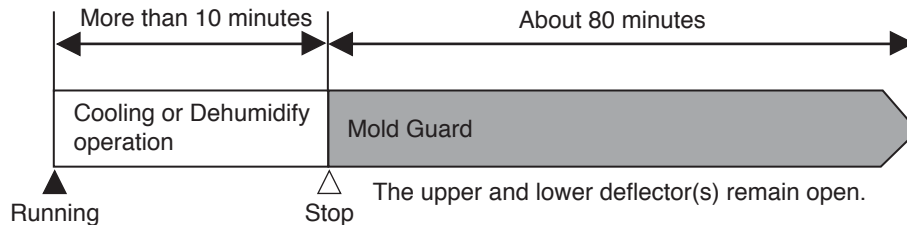

## The Process of Mold Guard





- “” Lamp on the indoor unit lights up during Mold Guard operation.
- If the air conditioner is operated in cooling or drying mode, including in auto mode, for more than 10 minutes and then put into off mode, the mold guard operation will start.
- If unit operation is stopped after heating operation, Mold Guard will not operate.
- Room temperature or humidity may rise

### ■ How to set and cancel Mold Guard



#### For setting

- 1 ● Press the room temperature up setting button and  (On Timer) button 3 seconds together during air conditioner operation stop.
- “” is displayed on the LCD.

#### For cancelling

- 2 ● Press the room temperature up setting button and  (On Timer) button 3 seconds together during air conditioner operation stop.
- “” is disappear on the LCD.
- Once Mold Guard function set, Mold Guard icon will always display on the LCD. And it stored in the memory of remote controller and remain set even after reset or battery replacement case. It is one time setting procedure to use this function.

### ■ How to stop at middle point of Mold Guard operation

- 3 ● Press the  (On/Off) button twice, the operation will stop.
- “” Lamp on the indoor unit turns off. But setting for Mold Guard will not cancel, it will stop the current operation only.

### NOTE

- If unit operation is stopped after heating operation, Mold Guard will not operate.
- If operation of Unit is stop by Off Timer or GoodSleep Timer, the Mold Guard will not operate.
- If On Timer is set and on time is within about 2 hours, the Mold Guard will not operate.
- Depending on situation, Mold Guard will operate with Fan Mode.
- Room temperature or humidity may rise.
- When there would be the window near the indoor unit, the water might condense on the window during Mold Guard. If necessary, cancel Mold Guard.

# ECO Operation

- Energy saving operation by changing set temperature and by limiting the maximum power consumption value.

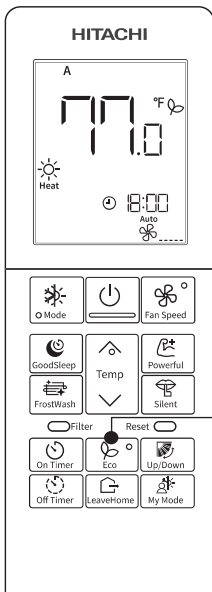

By pressing the  (ECO) button during Heating, Automatic Dehumidifying or Cooling operation, the air conditioner performs the “ECO” operation.

Press  (ECO) button during operation.

## START

- “” is displayed on the LCD.
- Energy saving operation will start by changing the set temperature higher or lower and saving operation power consumption.

Press  (On/Off) button.



## CANCEL

- Press  (ECO) button again.
- “” disappears from the LCD.

## NOTE



- In case the power consumption is already low, ECO operation will not reduce the power consumption.
- By pressing Powerful button, Mode button, LeaveHome button or My mode button, ECO operation will be cancelled.
- After auto restart, ECO operation is cancelled and previous operation mode shall start.

# Silent Operation

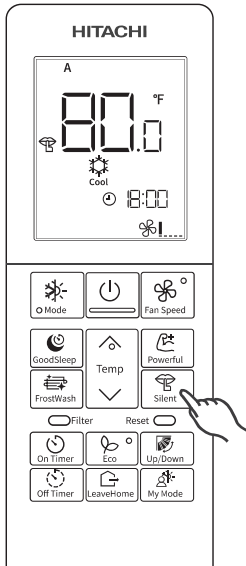

By pressing the  (Silent) button during Auto, Heat, Dry, Cool or Fan operation, the fan speed changes to the silent fan speed  .



## START

- When  (Silent) button is pressed,
- “” is displayed on the LCD.
- Fan speed changes to silent  .



## CANCEL

- Press the  (On/Off) button, or
- Press the  (Silent) button once again or
- Press the  (Fan Speed) button.

Fan speed will return to the previous speed before Silent operation starts.

When Silent operation stops, “” will disappear from the LCD.

## NOTE

- When Powerful operation is selected, Silent operation will be cancelled. Fan speed will return to the previous speed before Silent operation.
- After unit auto restart, Silent operation is cancelled. Fan speed will return to the previous speed before Silent operation.
- During any operations with silent fan speed , if user presses the  (Silent) button, the fan speed does not change.
- By pressing Mode button or LeaveHome button or My mode button, Silent operation is cancelled.



# GoodSleep Timer Setting

By pressing the  (GoodSleep) button during Auto, Heat, Dry, Cool or Fan operation, the unit shifts the room temperature and reduces the fan speed.

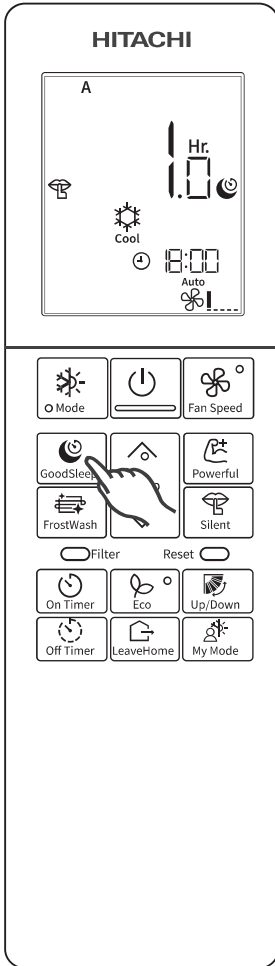

| Mode            | Indication   |
|-----------------|--|
| GoodSleep Timer | Set Temp. -0.5Hr. -1.0Hr. -2.0Hr. -3.0Hr. .... → 10.0Hr. -11.0Hr. -12.0Hr.<br>(Cancel GoodSleep Timer) |

During GoodSleep Timer the unit will continue working for the designated number of hours.

## START



When  (GoodSleep) button is pressed.

- Timer information is displayed on the LCD.
- The timer Lamp lights up and a beep sound is emitted from the indoor unit.

## CANCEL

- Press the  (On/Off) button.

Room air conditioner will enter Standby mode.

- Press the  (GoodSleep) button again until timer cancels.  
 “” and number of hours will disappear from the LCD.  
 The timer Lamp turns off and a beep sound is emitted from the indoor unit.

## NOTE

- The indoor fan speed of air conditioner does not change even when fan speed button is pressed.
- If you set the GoodSleep Timer when the Off Timer or On Timer has been set earlier, the GoodSleep Timer becomes effective instead of the Off Timer or On Timer set earlier.
- On Timer and Off Timer can not be set if GoodSleep Timer set earlier.
- GoodSleep Timer will be cancelled if selected My Mode or LeaveHome Operation.

# Fan Mode

User can use the device simply as an air circulator.

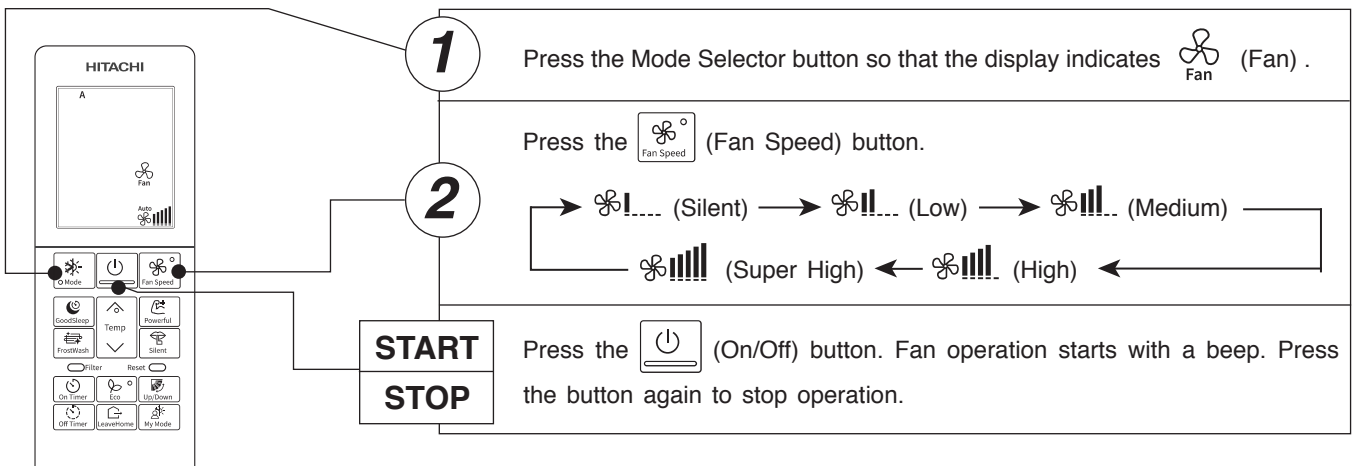

# Adjusting the Airflow Direction

- Adjust the airflow upward and downward.

According to operation, the horizontal air deflector is automatically set to the proper angle suitable for each operation. The deflector can be swung up and down and also set to the desired angle using the “ (Up/Down)” button.

Press the “ (Up/Down)” button. The deflector will start to swing up and down.

“” is display on LCD screen.

Press the “ (Up/Down)” button again. The deflector(s) will stop in the current position.

“” is disappear on LCD screen.

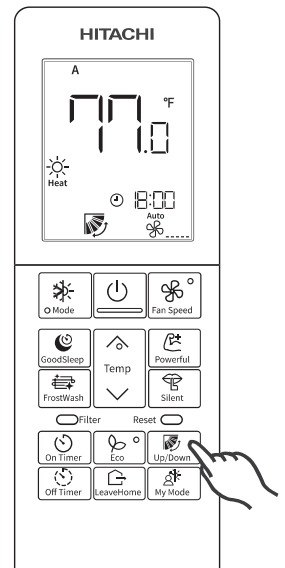

- If the “ (Up/Down)” button is pressed once, the horizontal air deflector swings up and down. If the button is pressed again, the deflector stops in its current position. Several seconds (about 6 seconds) may be required before the deflector starts to move.
- When the operation is stopped, the horizontal air deflector moves and stops at the position where the air outlet closes.

## CAUTION

- In “Cooling” operation, do not keep the horizontal air deflector swinging for a long time. Some dew may form on the horizontal air deflector and some dew may drop from it.

- Adjust the airflow to left and right**

Hold the vertical air deflector with a holder to adjust the airflow to left and right.

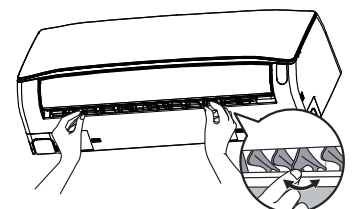

# My Mode(Programming)

- Use this mode for personalized comfortable settings. The My Mode can be set by using the remote controller.
- Up to 3 programs can be set.

## Programming of My Mode

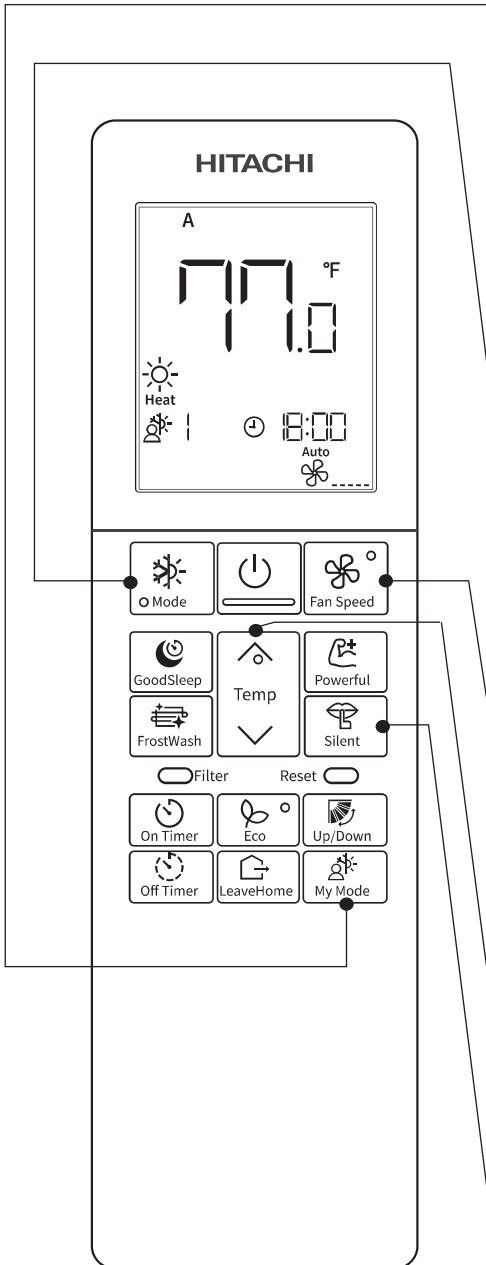

### Default Setting of My Mode

| My Mode   | Mode | Temperature | Fan Speed | ON Timer / OFF Timer | Silent     |
|-----------|------|-------------|-----------|----------------------|------------|
| My Mode 1 | COOL | 77°F        | Auto      | No setting           | No setting |
| My Mode 2 | COOL | 77°F        | Auto      | No setting           | No setting |
| My Mode 3 | COOL | 77°F        | Auto      | No setting           | No setting |

### Enter to My Mode programming

- Press the My Mode button continuously for 5 seconds.
  - “” blinks on the LCD. And “1”, “2” or “3” appear at the right of “”.
  - The blinking of “” will remain for 10 seconds.
  - By pressing the (My Mode) button, “1”, “2” or “3” can be selected for programming.

### Mode Selection

- Press (Mode) button in order to select desired Mode during “” blinks.
  - Mode will change from (Heat) → (Auto) → (Cool) → (Dry) → (Fan) cyclically.

### Fan Speed Selection

- Press (Fan Speed) button in order to select desired Fan Speed during “” blinks.
  - Available Fan speed only can be selected as per selected desired mode.

### Desired Room Temperature Selection

- Press button or button in order to select desired Room Temperature during “” blinks.
  - Temperature range can be set between 60°F and 90°F.
  - Fan Mode can not be set desired Room Temperature.

### Silent Mode Selection



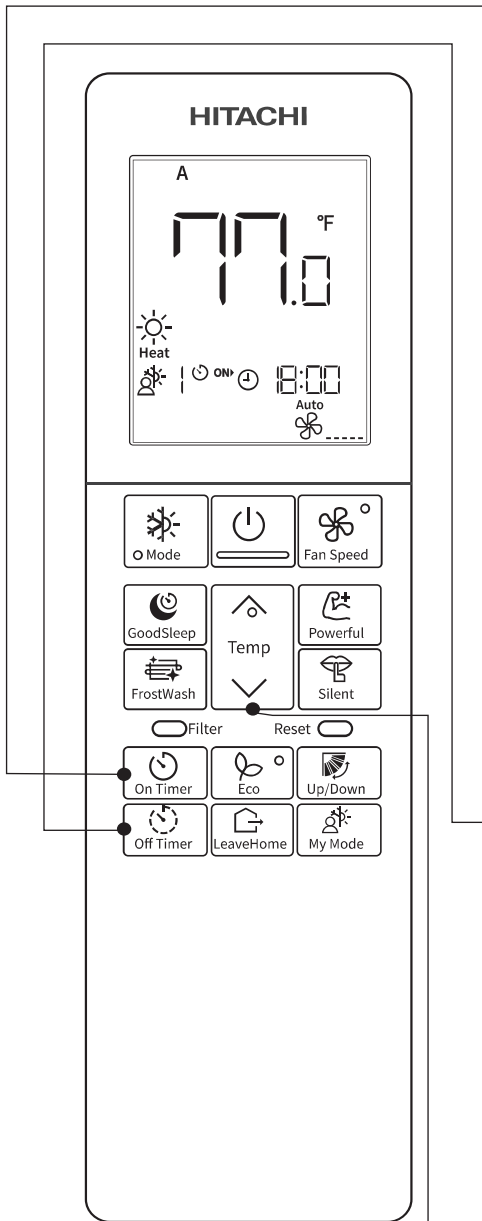

- Press (Silent) button in order to set or cancel Silent Mode during “” blinks.

# My Mode(Programming)





## Programming of My Mode





### On Timer Setting

- Press  (On Timer) button to select ON timer.
  -  **ON** Symbol start blinking on LCD screen. ON Timer time will be display on clock time segment on LCD.
- Press  button to set desire ON timer.
- Press  button. It will set ON timer programming.
  -  **ON** Symbol stop blinking on LCD screen.
  - Remote controller will go to ON mode after ON timer elapse.
  - To cancel ON timer, press On Timer button and Off Timer button together for 3 seconds.

### Off Timer Setting

- Press  (Timer OFF) button to select OFF timer.
  -  **OFF** Symbol start blinking on LCD screen. OFF Timer time will be display on clock time segment on LCD.
- Press  button to set desire OFF timer.
- Press  button. It will set OFF timer programming.
  -  **OFF** Symbol stop blinking on LCD screen.
  - To cancel OFF timer, press On Timer button and Off Timer button together for 3 seconds.
  - Remote controller will go to OFF mode after OFF timer elapse.

### Register of My Mode Programming

- Once all desire setting completed, press  (On/Off) button during "" blinks. All selection will be saved to remote controller and room air conditioner.

### NOTE



- If operation of remote controller will not be done for 10 seconds during My Mode programming, remote controller will come out from My Mode programming without registering of My Mode Programming. Without registering of My Mode Programming, My Mode selection will remain with all previously selections and previous values.
- If My Mode button is kept pressing for 5 seconds during My Mode Programming, remote controller will come out from My Mode programming. Without registering of My Mode Programming, My Mode selection will remain with all previously selections and previous values.
- If battery is replaced or  (Reset) button is pressed, My Mode Programming on remote controller will be reset to default settings. If new settings are required, do My Mode Programming again.
- When Operation Mode Lock is set, selectable mode during My Mode will be limited.

# My Mode(Start or Stop of My Mode Operation)

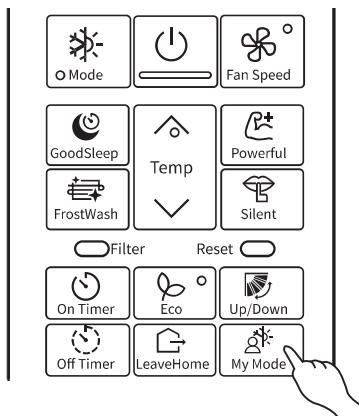
## Start of My Mode Operation



### Start of My Mode Operation

- Press  (My Mode) button at room air conditioner operation.
- Room air conditioner starts with My Mode 1 registered to remote controller.
- Press  (My Mode) button again in order to change to the operation of My mode 2, My mode 3.

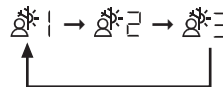

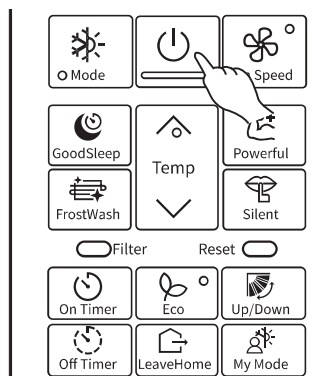

## Stop of My Mode Operation



### Stop of My Mode Operation

- Press  (On/Off) button in order to turn off room air conditioner

### NOTE

- My Mode operation can be cancelled by pressing  (Mode) button or  (LeaveHome) button.
- If My Mode Operation is started without programming of My Mode yet, room air conditioner starts with default setting of My Mode.
- If On Timer or Off Timer set by My Mode has elapsed, pressing  (My Mode) button again to restart the Timer operation.
- FrostWash (Manual Mode) will not activate during My Mode.
- Up/Down button is active during My mode for adjusting horizontal air deflector.

# Operation Mode Lock

The remote controller can be set to fix the Heat Mode (including Fan Mode), Cool Mode and Dry Mode (including Fan Mode) operations.

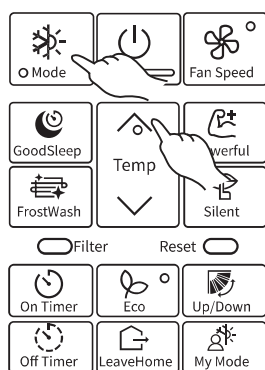

## ■ Method to lock Heat Mode (including Fan Mode) operation.

Press (Mode) and buttons simultaneously for about 3 seconds when the remote controller is OFF.

“ ”, “ ” and “ ” will be displayed for about 10 seconds. Later, “ ” and “ ” will remain.

This indicates that Heat Mode operation is locked.

When pressing (Mode) button, “ ” or “ ” will be displayed.

## ■ Method to unlock Heat Mode (including Fan Mode) operation.

Press (Mode) and buttons simultaneously for about 3 seconds when the remote controller is OFF.

All operation mode symbols will appear on the display for about 10 seconds “ ” will disappear. After that, “ ” will remain.

This indicates that Heat Mode operation is unlocked.

## ■ Method to lock Cool Mode and Dry Modes (including Fan Mode) operations.

Press (Mode) and buttons simultaneously for about 3 seconds when the remote controller is OFF.

“ ”, “ ”, “ ” and “ ” will be displayed for about 10 seconds. Later, “ ” and “ ” will remain.

This indicates that Cool Mode and Dry Mode operation is locked.

When pressing (Mode) button, “ ”, “ ” or “ ” will be displayed.

## ■ Method to unlock Cool Mode and Dry Mode (including Fan Mode) operations.

Press (Mode) and buttons simultaneously for about 3 seconds when the remote controller is OFF.

All operation mode symbols will appear on the display for about 10 seconds “ ” will disappear. After that, “ ” will remain.

This indicates that Cool Mode and Dry Modes operation is unlocked.

### NOTE

- Operation Mode Lock function will not activate if Timer reservations or My Mode is activate. Timer reservations shall be deactivated first. Then, Operation Mode Lock function can be activated.
- Operation Mode Lock can be kept even if (Reset) button is pressed.
- Operation Mode Lock will not be set if FrostWash (Manual Mode) is in progress.
- LeaveHome button is disable during lock Cool mode and Dry Mode operation.

# How to Reset Filter Sign on the indoor unit

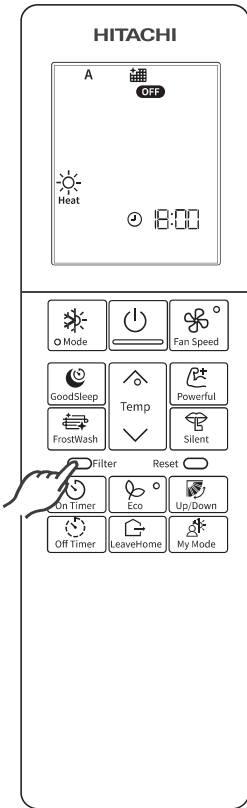

Filter Sign on the indoor unit will show with “” lamp by blinking with 1 second on and 4 seconds off. Because cleaning of Air filter has not been done for a long time.

Clean the Air filter.

Press Filter button at Off Mode pointing the remote controller towards the indoor unit to reset Filter Sign.

“” symbol will be visible on LCD screen for about 3 seconds and Filter Sign on the indoor unit will turn off.

### NOTE

- Filter button is active in OFF mode only.

# Reset Function (For Hardware Reset)

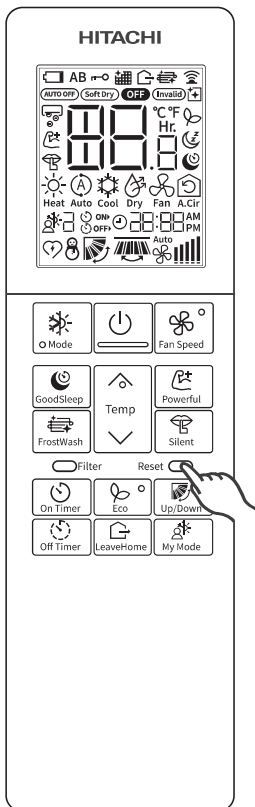

During batteries replacement or any unlikely event, if the display does not change on Press of key or any unwanted garbage display comes, Press Reset button to reset your remote controller hardware.

In order to reset remote controller hardware, press and release Reset button, the display will be as shown for 2 seconds then it will change to default mode screen.

### NOTE

- Use some pointed item like pen to press the reset key.
- Once the remote controller is reset, all setting will reset except some special function activated by user.

# THE IDEAL WAYS OF OPERATION

## Suitable Room Temperature



### ⚠ Warning

Freezing temperature is bad for health and a waste of electric power.

## Install curtain or blinds

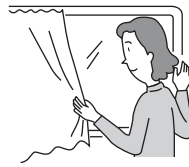

It is possible to reduce heat entering the room through windows.

## Ventilation



### ⚠ Caution

Do not close the room for a long period of time. Occasionally open the door and windows to allow the entrance of fresh air.

## Do Not Forget To Clean The Pre-Filter

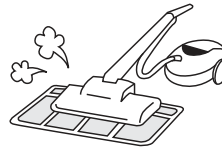

Dusty air filter will reduce the air volume and the cooling efficiency. To prevent from wasting electric energy, please clean the filter every 2 weeks.

## Effective Usage Of Timer

At night, please use the "OFF or ON timer or SLEEP timer operation mode", together with your wake up time in the morning. This will enable you to enjoy a comfortable room temperature. Please use the timer effectively.



## Please Adjust Suitable Temperature For Baby And Children



Please pay attention to the room temperature and air flow direction when operating the unit for baby, children and old folks who have difficulty in movement.

# FOR USER'S INFORMATION

## The Air Conditioner And The Heat Source In The Room

### ⚠ Caution

If the amount of heat in the room is above the cooling capability of the air conditioner (for example: more people entering the room, using heating equipments and etc.), the preset room temperature cannot be achieved.

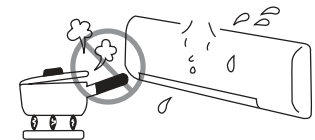

## Not Operating For A Long Time

When the indoor unit is not to be used for a long period of time, please switch off the power from the mains. If the power from mains remains "ON", the indoor unit still consumes about 3W in the operation control circuit even if it is in "OFF" mode.

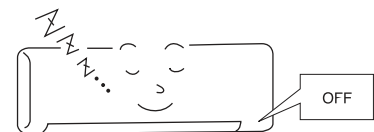

## When Lightning Occurs

### ⚠ Warning

To protect the whole unit during lightning, please stop operating the unit and remove the plug from the socket.

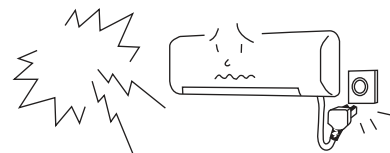

## Interference From Electrical Products

### ⚠ Caution

To avoid noise interference, please place the indoor unit and its remote controller at least 1m away from electrical products.

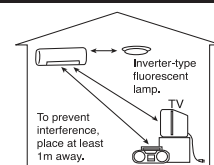



## AIRFLOW LOUVERS ADJUSTMENTS

---

Adjustment of the conditioned air to the left and right.

Hold the second vertical louver of each set of vertical louver from right as shown in the figure and adjust the conditioned air to the left or right.

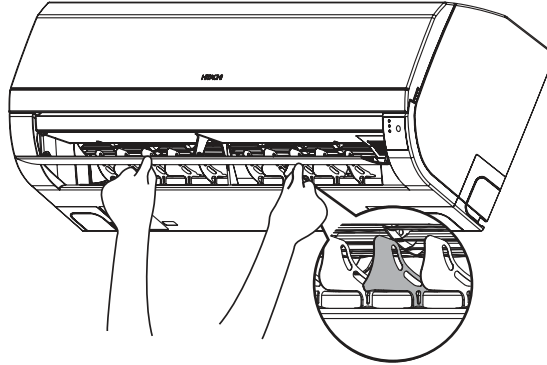

---

**⚠ WARNING**

Do not insert a finger, a rod or other objects into the air outlet or inlet as the fan is rotating at a high speed, it will cause injury. Before any cleaning or adjusting the louvers, be sure to switch OFF the operation.

# ATTACHING THE AIR PURIFYING FILTERS

## 1 Open the front panel

- Pull up the front panel by holding it at both sides with both hands.

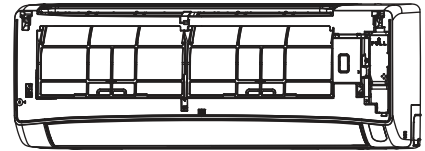

## 2 Remove the Pre-filter

- Push upward to release the claws and pull out the Pre-filter.

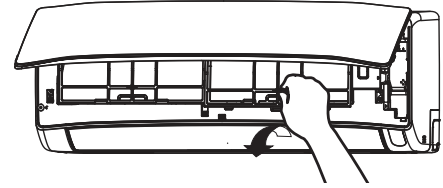

## 3 Attaching the air purifying filters (Accessories) to the filter frame.

- Attach the air purifying filters to the C-case to the designated position.
- The cooling capacity is slightly weakened and the cooling speed becomes slower when the air purifying filters are used.
- The air purifying filters are not washable. It is recommended to use vacuum to clean. It can be used for 1 year. When you want to renew it, please ask your sales agent.

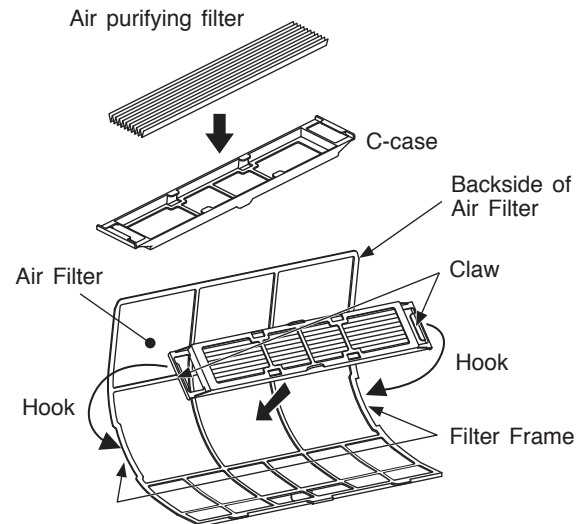

### CAUTION

Do not bend the air purifying filter as it may cause damage to the structure.

Please do not smell direct from source of filter.

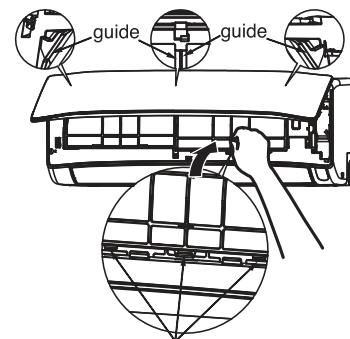

insert the hook to the hole

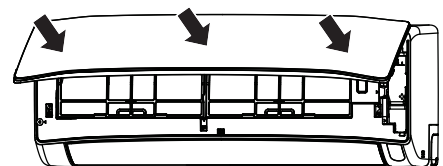

## 4 Attach the Pre-filters

- Attach the Pre-filters by ensuring that the surface written "FRONT" is facing front.
- After attaching the Pre-filters, push the front panel at three arrow portions as shown in figure and close it.

### NOTE

- In case of removing the air purifying filters, please follow the above procedures.
- The cooling capacity is slightly weakened and the cooling speed becomes slower when the air purifying filters are used. So, set the fan speed to "HIGH" when using it in this condition.
- Air purifying filters are not washable. It is recommended to use vacuum to clean it. It can be use for 1 year time. Type number for this air purifying filter is <SPX-CFH22AC25>. Please use this number for ordering when you want to renew it.
- Do not use detergent on the air purifying filter as some detergent may deteriorate the air purifying filter electrostatic performance.

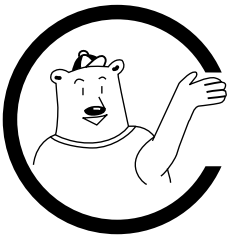

# MAINTENANCE

## ⚠ CAUTION

Before cleaning, stop operation and switch off the power supply.

### 1. PRE-FILTER

Clean the Pre-filter, as it removes dust inside the room. In case the Pre-filter is full of dust, the air flow will decrease and the cooling capacity will be reduced. Further, noise may occur. Be sure to clean the Pre-filter following the procedure below.

#### PROCEDURE

- 1 Open the front panel and remove the Pre-filter
  - Gently lift and remove the air purifying filters from the air purifying filter frame.

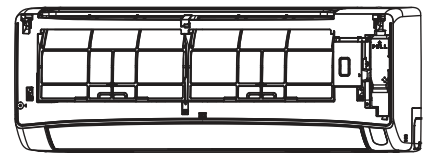

- 2 Vacuum dust from the Pre-filter and air purifying filter using vacuum cleaner. If there is too much dust, rinse under running tap water and gently brush it with soft bristle brush. Allow filters to dry in shade.

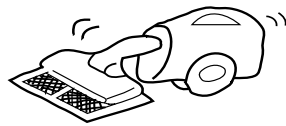
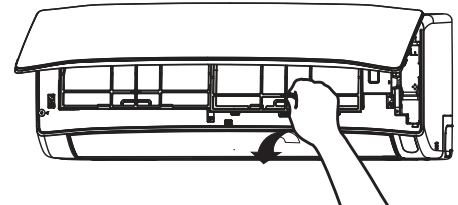

- 3
  - Re-insert the air purifying filter to the filter frame. Set the Pre-filter with "FRONT" mark facing front, and slot them into the original state.
  - After attaching the Pre-filters, push the front panel at three arrow portions as shown in figure and close it.

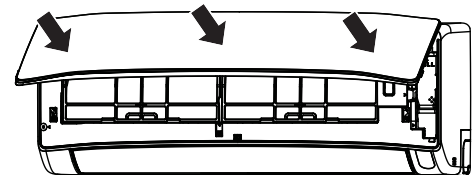
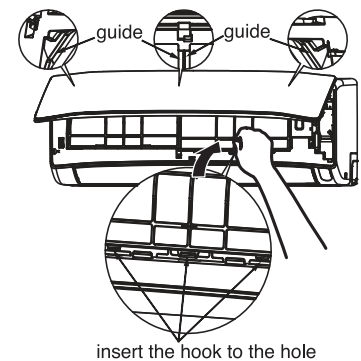

## ⚠ CAUTION

- Do not wash with hot water at more than 104°F(40°C). The Pre-filters may shrink.
- When washing it, shake off moisture completely and dry it in the shade; do not expose it directly to the sun. The Pre-filters may shrink.
- Do not use detergent on the Pre-filter as some detergent may deteriorate the Pre-filter electrostatic performance.

## 2. CLEANING OF FRONT PANEL

- Remove the front panel and wash with clean water. Wash it with a soft sponge. After using neutral detergent, wash thoroughly with clean water.
- When front panel is not removed, wipe it with a soft dry cloth. Wipe the remote controller thoroughly with a soft dry cloth.
- Wipe the water thoroughly. If water remains at indicators or signal receiver of indoor unit, it causes trouble.

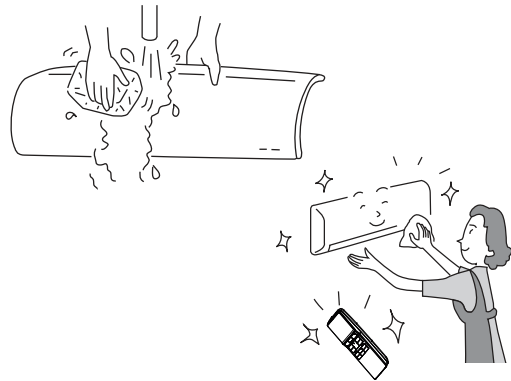

Method of removing the front panel.

Be sure to hold the front panel with both hands to detach and attach it.

### Removing the Front Panel

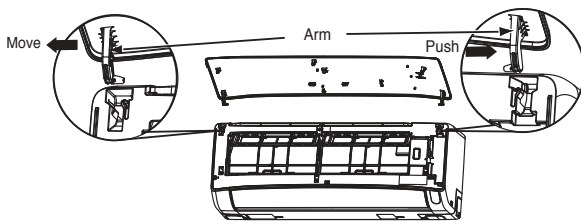

- When the front panel is fully opened with both hands, push the right arm to the outside to release it, and while closing the front panel slightly, pull it out forward.

### Attaching the Front Panel

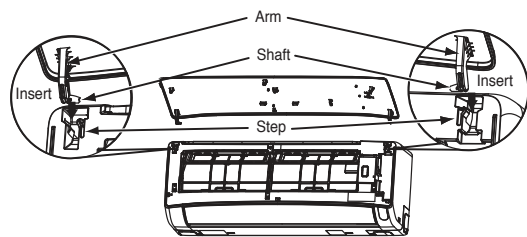

- Move the projections of the left and right arms into the Flanges in the unit and securely insert them into the holes.

### CAUTION

- Never use hot water (above 104°F(40°C)), benzene, gasoline, acid, thinner or a brush, because they will damage the plastic surface and the coating.



## WIRING ARRANGEMENT

### CAUTION

- Please use earth line. Do not place the earth line near water or gas pipes, lightning-conductor, or the earth line of telephone. Improper installation of earth line may cause electric shock
- A circuit breaker should be installed depending on the mounting site of the unit. Without a circuit breaker, the danger of electric shock exists.



### IMPORTANT

The wires in this mains lead are coloured in accordance with the following code:

|                  |           |
|------------------|-----------|
| Green-and-yellow | : Earth   |
| Blue             | : Neutral |
| Brown            | : Live    |

As the colours of the wires in the mains lead of this appliance may not correspond with the coloured markings identifying the terminals in your plug, proceed as follows:

The wire which is coloured green-and-yellow must be connected to the terminal in the plug which is marked with the letter E or by the earth symbol (⊕) or coloured green or green-and-yellow.

The wire which is coloured blue must be connected to the terminal which is marked with the letter N or coloured black.

The wire which is coloured brown must be connected to the terminal which is marked with the letter L or coloured red.

### NOTE



If the supply cord is damaged, it must be replaced by the special cord obtainable at authorized service/parts centers.

### CAUTION

Cleaning and maintenance must be carried out only by qualified service personnel. Before cleaning, stop operation and switch off the power supply.

## Regular Inspection

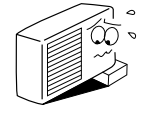
PLEASE CHECK THE FOLLOWING POINTS BY QUALIFIED SERVICE PERSONNEL EITHER EVERY HALF YEARLY OR YEARLY. CONTACT YOUR SALES AGENT OR SERVICE SHOP.

|          |   |   |
|----------|---|---|
| <b>1</b> |  | Is the earth line disconnected or broken?   |
| <b>2</b> |  | Is the mounting frame seriously affected by rust and is the outdoor unit tilted or unstable?                |
| <b>3</b> |  | Is the plug of power line firmly plugged into the socket?<br>(Please ensure no loose contact between them). |

## AFTER SALE SERVICE AND WARRANTY

### WHEN ASKING FOR SERVICE, CHECK THE FOLLOWING POINTS

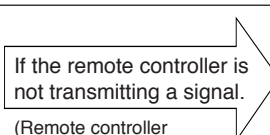
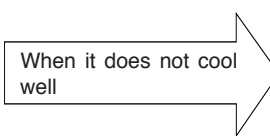
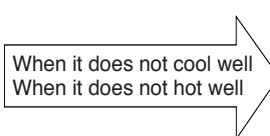
| CONDITION   | CHECK THE FOLLOWING POINTS   |
|---|--|
| <br>If the remote controller is not transmitting a signal.<br>(Remote controller display is dim or blank.) | <ul style="list-style-type: none"> <li>Do the batteries need replacement?</li> <li>Is the polarity of the inserted batteries correct?</li> </ul>   |
| <br>When it does not cool well   | <ul style="list-style-type: none"> <li>Is the fuse all right?</li> <li>Is the voltage extremely high or low?</li> <li>Is the circuit breaker "ON"?</li> <li>Is the setting of operation mode different from other indoor units?</li> </ul>   |
| <br>When it does not cool well<br>When it does not heat well   | <ul style="list-style-type: none"> <li>Is the pre-filter blocked with dust?</li> <li>Does sunlight fall directly on the outdoor unit?</li> <li>Is the air flow of the outdoor unit obstructed?</li> <li>Are the doors or windows opened, or is there any source of heat in the room?</li> <li>Is the set temperature suitable?</li> <li>Are the air inlets or air outlets of indoor and outdoor units blocked?</li> <li>Is the fan speed "LOW" or "SILENT"?</li> </ul> |

## FrostWash Operation

|   |   |
|---|---|
| FrostWash Operation does not start  | <p>It does not wash when outside temperature is less than about 1 degrees Celsius or more than 43 degrees Celsius.</p> <p>It does not wash when the humidity in the room is about 30% or less or about 70% or more.</p> <p>When "FrostWash" is done by operating a remote controller, it does not wash when the room temperature is less than about 10 degrees Celsius or more than about 32 degrees Celsius.</p> <p>When 60 minutes after the end of "FrostWash", "FrostWash" is not operated for product protection.</p>  |
| Noise occurred during FrostWash operation   | <p>It is the sound that the internal machine is inflated and contracted by the temperature change and the fin of the heat exchanger is frozen and thawed</p>  |
|  (Clean Function Lamp) blinks | <p>Repeat for 1 second on and 1 second off for 10 seconds</p> <p>Because "FrostWash" can not work when operating the "FrostWash" with remote controller.</p> <ul style="list-style-type: none"> <li>The air conditioner is operating</li> <li>Outside air temperature, room temperature and room humidity are not suitable for "FrostWash"</li> <li>It has not been over 60 minutes since the end of "FrostWash"</li> </ul> <p>Repeat for 4 seconds on and 1 second off for 15 seconds</p> <p>Because FrostWash has not been done for a long time.</p> <p>→ Operate the remote controller to operate "FrostWash".</p> |

## Mold Guard Operation

|                                     |   |
|-------------------------------------|---|
| Mold Guard operation does not start | <p>If the air conditioner operation is stopped after heating operation, Mold Guard will not operate.</p> <p>If the air conditioner has operated in cooling and drying mode, including auto mode, for less than 10 minutes, the Mold Guard operation will not start even if the air conditioner is in off mode.</p> <p>If operation of the air conditioner is stop by OFF Timer or GoodSleep Timer, the Mold Guard will not operate.</p> <p>If ON Timer is set and on time is within about 2 hours, the Mold-Guard will not operate.</p> |
| During Mold Guard                   | <p> (Clean Function Lamp) on the indoor unit lights up during Mold Guard operation. If Mold Guard operation stop at middle point, FrostWash and Filter sign indicator will turn off.</p>   |

|       |  |
|-------|--|
| Notes | <p>The horizontal deflector remain open. Room temperature or humidity may rise. Depending on situation, Mold Guard will operate with Fan Mode.</p> <p>When there would be the window near indoor unit, the water might condense on the window during Mold Guard. If necessary, to cancel Mold Guard.</p> <p>When after FrostWash operation, the water inside the indoor unit evaporates and depending on the room conditions, may emitted as steam. But this is not a malfunction. If necessary, to cancel Mold-Guard.</p> |
|-------|--|

|  |  |
|--|--|
| The OPERATION lamp is flashing         | Shows preheating or defrosting operation is underway. As the protective circuit or preheat sensor operates when unit operation is stopped during preheating and then restarted, or when operation mode is switched from cooling to heating, the lamp continues to blink. |
| Does not reach the temperature setting | Actual room temperature may deviate slightly from the remote controller's temperature setting depending on the number of people in the room, indoor or outdoor conditions.   |



■ The following phenomena do not indicate unit failure.

|   |   |
|---|---|
| During heating, the operation indicator blinks and air blow stops   | <p>&lt;Operation start&gt;<br/>The unit is preparing to blow warm air. Please wait.</p> <p>&lt;In operation&gt;<br/>The outdoor unit is defrosting. Please wait.</p>                                    |
| Hissing or fizzy sounds   | Refrigerant flow noise in the pipe or valve sound generated when flow rate is adjusted.   |
|   | Refrigerant flow noise occur during changes of maximum fan speed to lowest speed.   |
| Squeaking noise   | Noise generated when the unit expands or contracts due to temperature changes.  |
| Rustling noise  | Noise generated with the indoor unit fan's rpm changing such as operation start times.  |
| Clicking noise  | Noise of the motorized valve when the unit is switched on.  |
| Perking noise   | Noise of the ventilation fan sucking in air present in the drain hose and blowing out dehumidifying water that had accumulated in the condensed water collector. For details, consult your sales agent. |
| Changing operation noise  | Operation noise changes due to power variations according to room temperature changes.  |
| Mist emission   | Mist is generated as the air within the room is suddenly cooled by conditioned air.   |
| Steam emitted from the outdoor unit                                 | Water generated during defrosting operation evaporates and steam is emitted.  |
| Odors   | Caused as the smells and particles of smoke, food, cosmetics, etc. present in room air become attached the unit and blown off into the room again.  |
| The outdoor unit continues to operate even if operation is stopped. | Defrosting is underway (as the heating operation is stopped, the microcomputer checks frost accumulated in the outdoor unit and instructs the unit to perform automatic defrosting if necessary).       |

If the unit still fails to operate normally after performing the above inspections, turn the circuit breaker off and contact your sales agent immediately.

**Contact your sales agent immediately if the following phenomena should occur**

- The circuit breaker switches off or the fuse blows frequently.
- The switch operation is not stable.
- Foreign matter or water accidentally enters the unit interior.
- The power cord gets excessively hot or its insulation is torn or stripped.
- TIMER lamp on the indoor unit display blinks. (As the nature of the failure can be identified by the blinking cycle, check the blinking cycle before turning off the circuit breaker.)

**Notes**

- In quiet or stop operation, the following phenomena may occasionally occur, but they are not abnormal for the operation.

- (1) Slight flowing noise of refrigerant in the refrigerating cycle.
- (2) Slight rubbing noise from the fan casing which is cooled and then gradually warmed as operation stops.

- The odor will possibly be emitted from the room air conditioner because the various odor, emitted by smoke, foodstuffs, cosmetics and so on, sticks to it. So the pre-filter and the evaporator regularly must be cleaned to reduce the odor.

Please contact your sales agent immediately if the air conditioner still fails to operate normally after the above inspections. Inform your agent of the model of your unit, production number, date of installation. Please also inform him regarding the fault.

**Please note:**

On switching on the equipment, particularly when the room light is dimmed, a slight brightness fluctuation may occur. This is of no consequence.

The conditions of the local Power Supply Companies are to be observed.

**Please note:**

On switching on the equipment, particularly when the room light is dimmed, a slight brightness fluctuation may occur. This is of no consequence.

The conditions of the local Power Supply Companies are to be observed.

**Note**

- Avoid using the room air conditioner for cooling operation when the outside temperature is below the minimum recommended temperature.

The recommended maximum and minimum operating temperatures of the hot and cold sides should be as below:

Single Split model connection (RAC-DJ\*\* series)

|         |          | Cooling        |                | Heating         |               |
|---------|----------|----------------|----------------|-----------------|---------------|
|         |          | Minimum        | Maximum        | Minimum         | Maximum       |
| Indoor  | Dry bulb | 70°F (21°C)    | 90°F (32°C)    | 68°F (20°C)     | 81°F (27°C)   |
|         | Wet bulb | 59°F (15°C)    | 73°F (23°C)    | –               | –             |
| Outdoor | Dry bulb | -0.4°F (-18°C) | 114.8°F (46°C) | -5°F (-20.55°C) | 75.2°F (24°C) |
|         | Wet bulb | –              | –              | –               | –             |

CONSTRUCTION AND DIMENSIONAL DIAGRAM

RAK-DJ24PHAA

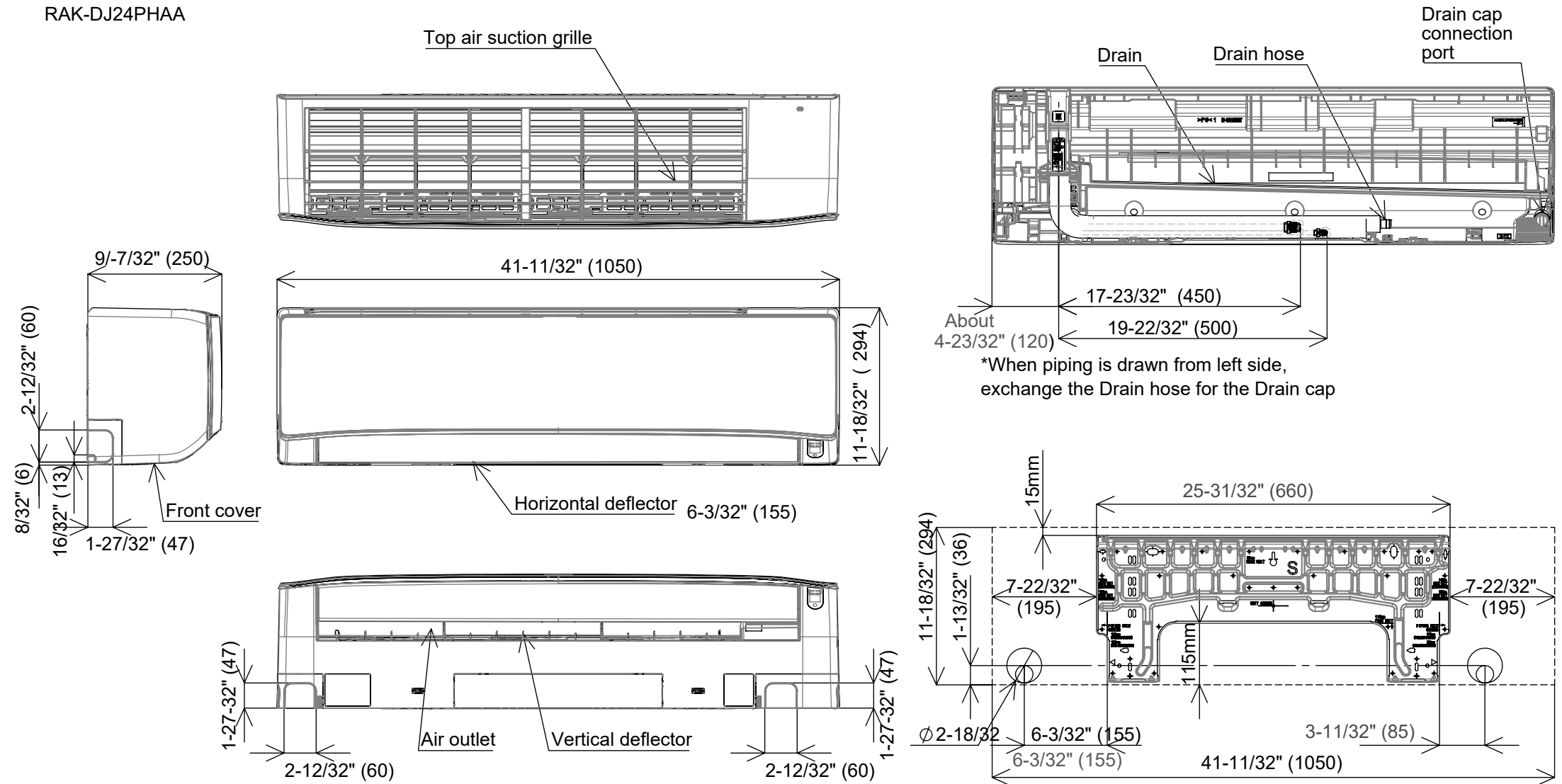



# MAIN PARTS COMPONENT

## THERMOSTAT (Room Temperature Thermistor)

### Thermostat Specifications

|                        |                  |     |              |              |
|------------------------|------------------|-----|--------------|--------------|
| MODEL                  |                  |     | RAK-DJ24PHAA |              |
| THERMOSTAT MODEL       |                  |     | IC           |              |
| OPERATION MODE         |                  |     | COOL         | HEAT         |
| TEMPERATURE<br>°C (°F) | INDICATION<br>16 | ON  | 18.3 (64.99) | 13.7 (56.61) |
|                        |                  | OFF | 15.0 (59.00) | 16.7 (62.06) |
|                        | INDICATION<br>24 | ON  | 26.3 (79.39) | 21.7 (71.01) |
|                        |                  | OFF | 23.0 (73.40) | 24.7 (76.46) |
|                        | INDICATION<br>32 | ON  | 34.3 (93.79) | 29.7 (85.41) |
|                        |                  | OFF | 31.0 (87.80) | 32.7 (90.86) |

## FAN MOTOR

### Fan Motor Specifications

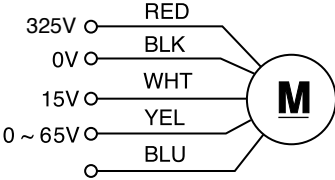
|              |  |
|--------------|--|
| MODEL        | RAK-DJ24PHAA   |
| POWER SOURCE | DC: 38V  |
| POWER OUTPUT | 30W  |
| CONNECTION   |  <p>(Control circuit built in)</p> |

BLU : BLUE

YEL : YELLOW

BRN : BROWN

WHT : WHITE

GRY : GRAY

ORN : ORANGE

GRN : GREEN

RED : RED

BLK : BLACK

PNK : PINK

VIO : VIOLET

# WIRING DIAGRAM

MODEL RAK-DJ24PHAA

BLK:BLACK YEL:YELLOW  
 BLU:BLUE GRN:GREEN  
 RED:RED WHT:WHITE  
 GRY:GRAY BRN:BROWN

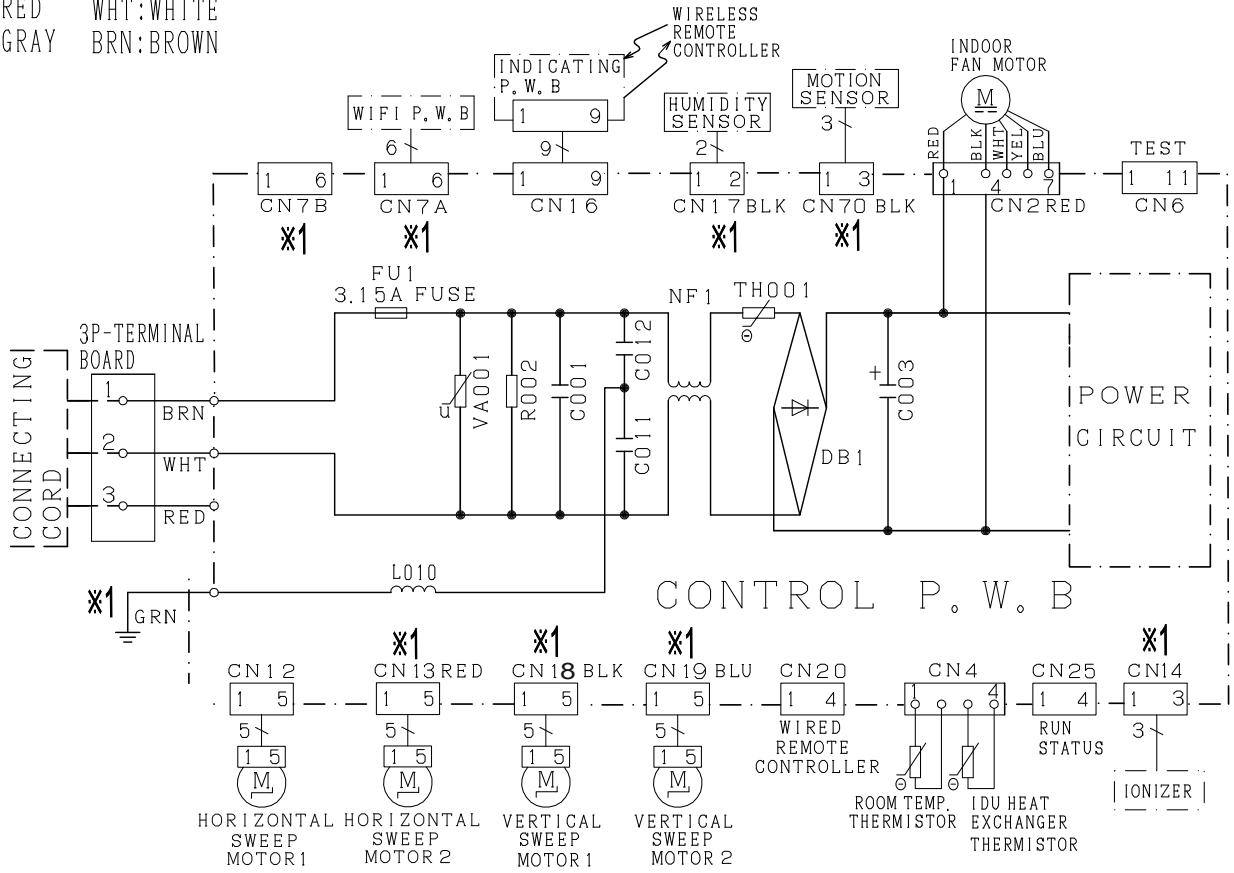

**\*1: SOME MODEL DO NOT HAVE THIS FUNCTION**

**CAUTION! TURN OFF THE POWER HIGH SOURCE DURING THE VOLTAGE SERVICE WORK.**

# WIRING DIAGRAM OF THE PRINTED WIRING BOARD

[Remote controller] (RC-AGU1EA0N)

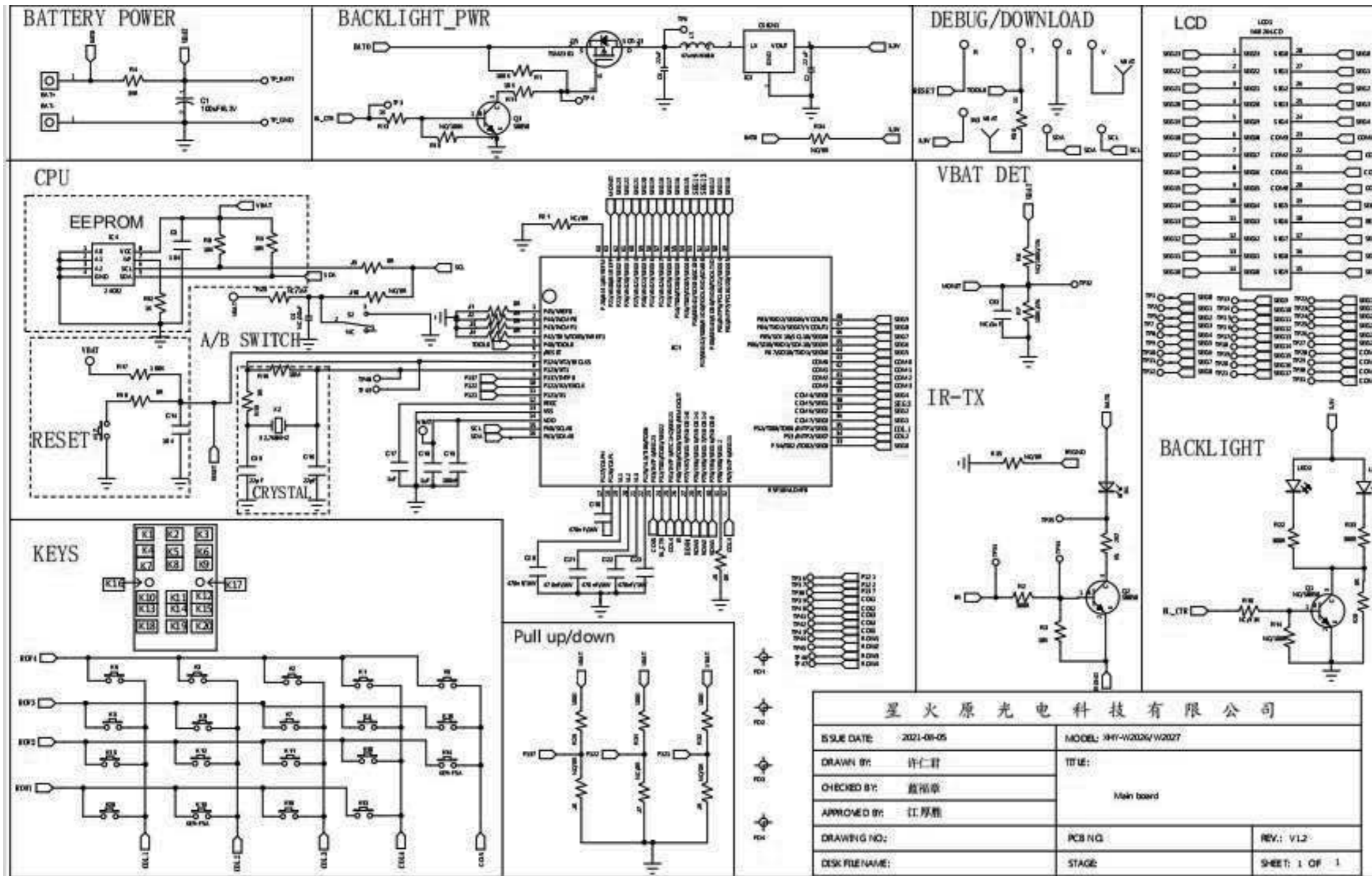

## HITACHI

Mode

Power

Fan Speed

GoodSleep

Temp

Powerful

FrostWash

Reset

Silent

On Timer

Eco

Up/Down

Off Timer

LeaveHome

My Mode

# CIRCUIT DIAGRAM

## MODEL RAK-DJ24PHAA

| Group  | A  | B   | C   | D            | E     | F |
|--------|----|-----|-----|--------------|-------|---|
| Region | EU | IND | SEA | EU/ANZEU/AMZ | CHINA |   |

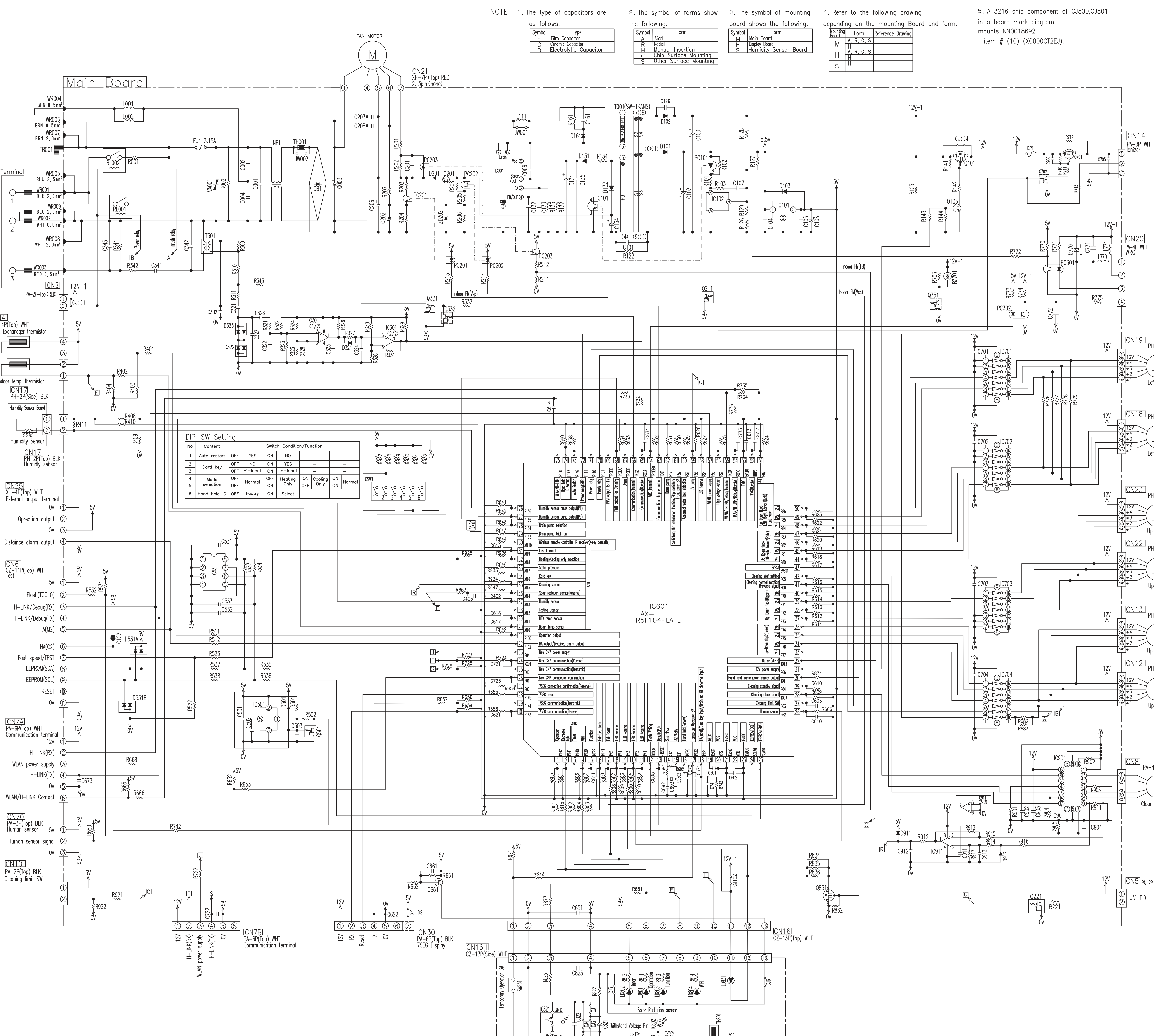

### Main Board

NOTE 1. The type of capacitors are as follows:

2. The symbol of forms show the following:

3. The symbol of mounting board shows the following:

4. Refer to the following drawing depending on the mounting Board form.

5. A 3216 chip component of C1800,C801 in a board mark diagram mounts N0018692, item # (10) (X000C2EJ).

Symbol | Type

| F | Film capacitor |
| G | General capacitor |
| D | Electrolytic Capacitor |

Symbol | Form

| A | Panel |
| B | Back |
| H | Manual insertion |
| T | Top Surface Mounting |
| S | Other Surface Mounting |

Symbol | Form

| M | Main Board |
| B | Back Board |
| M | Mini Board |
| H | A, R, C, S |
| H | A, R, C, S |
| S |  |

Symbol | Form

| A | Panel |
| B | Back |
| H | Manual insertion |
| T | Top Surface Mounting |
| S | Other Surface Mounting |

| Resistor | Symbol | Resistance | Power | Temp | Material | Mount | Form | Group | Part Number | Notes  |
|----------|--------|------------|-------|------|----------|-------|------|-------|-------------|--------|
| R001     | 510    | 5%         | 1/4   | A    | M        | O     | O    | O     | 100         | 10005  |
| R002     | 1M     | 5%         | 1/4   | A    | M        | O     | O    | O     | 100         | 10005  |
| R101     | 1k     | 5%         | 1/4   | A    | M        | O     | O    | O     | 100         | 10005  |
| R102     | 1.5k   | 5%         | 1/4   | A    | M        | O     | O    | O     | 100         | 10005  |
| R103     | 10k    | 5%         | 1/4   | A    | M        | O     | O    | O     | 100         | 10005  |
| R105     | 33k    | 5%         | 1/4   | A    | M        | O     | O    | O     | 100         | 10005  |
| R112     | 33M    | 5%         | 1/2   | A    | M        | O     | O    | O     | 182         | 1608A0 |
| R116     | 10k    | 5%         | 1/4   | A    | M        | O     | O    | O     | 100         | 10005  |
| R117     | 330k   | 5%         | 1/4   | A    | M        | O     | O    | O     | 100         | 10005  |
| R120     | 100k   | 5%         | 1/4   | A    | M        | O     | O    | O     | 100         | 10005  |
| R129     | 6.2k   | 1%         | 1/10  | C    | M        | O     | O    | O     | 47          | 1608   |
| R132     | 1.2k   | 5%         | 1/4   | A    | M        | O     | O    | O     | 100         | 10005  |
| R133     | 330k   | 5%         | 1/4   | A    | M        | O     | O    | O     | 100         | 10005  |
| R134     | 22k    | 5%         | 1/4   | A    | M        | O     | O    | O     | 100         | 10005  |
| R141     | 100k   | 5%         | 1/16  | C    | M        | O     | O    | O     | 106         | 10005  |
| R142     | 100k   | 5%         | 1/16  | C    | M        | O     | O    | O     | 106         | 10005  |
| R143     | 3.3k   | 5%         | 1/16  | C    | M        | O     | O    | O     | 99          | 10005  |
| R144     | 3.3k   | 5%         | 1/16  | C    | M        | O     | O    | O     | 99          | 10005  |
| R161     | 220k   | 5%         | 1/4   | A    | M        | O     | O    | O     | 178         | 1608A0 |
| R201     | 4.3k   | 5%         | 1/4   | A    | M        | O     | O    | O     | 36          | 3216   |
| R202     | 4.3k   | 5%         | 1/4   | A    | M        | O     | O    | O     | 69          | 1608   |
| R203     | 4.7k   | 5%         | 1/10  | C    | M        | O     | O    | O     | 43          | 3216   |
| R204     | 3.3k   | 5%         | 1/10  | C    | M        | O     | O    | O     | 68          | 1608   |
| R205     | 402    | 1%         | 1/4   | A    | M        | O     | O    | O     | 39          | 3216   |
| R206     | 33k    | 5%         | 1/10  | C    | M        | O     | O    | O     | 73          | 1608   |
| R207     | 100k   | 5%         | 1/10  | C    | M        | O     | O    | O     | 59          | 1608   |
| R211     | 12k    | 5%         | 1/16  | C    | M        | O     | O    | O     | 101         | 10005  |
| R212     | 12k    | 5%         | 1/16  | C    | M        | O     | O    | O     | 101         | 10005  |
| R213     | 390k   | 5%         | 1/8   | C    | M        | O     | O    | O     | 40          | 3216   |
| R214     | 560k   | 5%         | 1/8   | C    | M        | O     | O    | O     | 29          | 3216   |
| R215     | 200k   | 5%         | 1/8   | C    | M        | O     | O    | O     | 39          | 3216   |
| R216     | 200k   | 5%         | 1/8   | C    | M        | O     | O    | O     | 41          | 3216   |
| R217     | 200k   | 5%         | 1/8   | C    | M        | O     | O    | O     | 41          | 3216   |
| R218     | 200k   | 5%         | 1/8   | C    | M        | O     | O    | O     | 41          | 3216   |
| R219     | 200k   | 5%         | 1/8   | C    | M        | O     | O    | O     | 41          | 3216   |
| R220     | 200k   | 5%         | 1/8   | C    | M        | O     | O    | O     | 41          | 3216   |
| R221     | 200k   | 5%         | 1/8   | C    | M        | O     | O    | O     | 41          | 3216   |
| R222     | 200k   | 5%         | 1/8   | C    | M        | O     | O    | O     | 41          | 3216   |
| R223     | 200k   | 5%         | 1/8   | C    | M        | O     | O    | O     | 41          | 3216   |
| R224     | 200k   | 5%         | 1/8   | C    | M        | O     | O    | O     | 41          | 3216   |
| R225     | 200k   | 5%         | 1/8   | C    | M        | O     | O    | O     | 41          | 3216   |
| R226     | 200k   | 5%         | 1/8   | C    | M        | O     | O    | O     | 41          | 3216   |
| R227     | 200k   | 5%         | 1/8   | C    | M        | O     | O    | O     | 41          | 3216   |
| R228     | 200k   | 5%         | 1/8   | C    | M        | O     | O    | O     | 41          | 3216   |
| R229     | 200k   | 5%         | 1/8   | C    | M        | O     | O    | O     | 41          | 3216   |
| R230     | 200k   | 5%         | 1/8   | C    | M        | O     | O    | O     | 41          | 3216   |
| R231     | 200k   | 5%         | 1/8   | C    | M        | O     | O    | O     | 41          | 3216   |
| R232     | 200k   | 5%         | 1/8   | C    | M        | O     | O    | O     | 41          | 3216   |
| R233     | 200k   | 5%         | 1/8   | C    | M        | O     | O    | O     | 41          | 3216   |
| R234     | 200k   | 5%         | 1/8   | C    | M        | O     | O    | O     | 41          | 3216   |
| R235     | 200k   | 5%         | 1/8   | C    | M        | O     | O    | O     | 41          | 3216   |
| R236     | 200k   | 5%         | 1/8   | C    | M        | O     | O    | O     | 41          | 3216   |
| R237     | 200k   | 5%         | 1/8   | C    | M        | O     | O    | O     | 41          | 3216   |
| R238     | 200k   | 5%         | 1/8   | C    | M        | O     | O    | O     | 41          | 3216   |
| R239     | 200k   | 5%         | 1/8   | C    | M        | O     | O    | O     | 41          | 3216   |
| R240     | 200k   | 5%         | 1/8   | C    | M        | O     | O    | O     | 41          | 3216   |
| R241     | 200k   | 5%         | 1/8   | C    | M        | O     | O    | O     | 41          | 3216   |
| R242     | 200k   | 5%         | 1/8   | C    | M        | O     | O    | O     | 41          | 3216   |
| R243     | 200k   | 5%         | 1/8   | C    | M        | O     | O    | O     | 41          | 3216   |
| R244     | 200k   | 5%         | 1/8   | C    | M        | O     | O    | O     | 41          | 3216   |
| R245     | 200k   | 5%         | 1/8   | C    | M        | O     | O    | O     | 41          | 3216   |
| R246     | 200k   | 5%         | 1/8   | C    | M        | O     | O    | O     | 41          | 3216   |
| R247     | 200k   | 5%         | 1/8   | C    | M        | O     | O    | O     | 41          | 3216   |
| R248     | 200k   | 5%         | 1/8   | C    | M        | O     | O    | O     | 41          | 3216   |
| R249     | 200k   | 5%         | 1/8   | C    | M        | O     | O    | O     | 41          | 3216   |
| R250     | 200k   | 5%         | 1/8   | C    | M        | O     | O    | O     | 41          | 3216   |
| R251     | 200k   | 5%         | 1/8   | C    | M        | O     | O    | O     | 41          | 3216   |
| R252     | 200k   | 5%         | 1/8   | C    | M        | O     | O    | O     | 41          | 3216   |
| R253     | 200k   | 5%         | 1/8   | C    | M        | O     | O    | O     | 41          | 3216   |
| R254     | 200k   | 5%         | 1/8   | C    | M        | O     | O    | O     | 41          | 3216   |
| R255     | 200k   | 5%         | 1/8   | C    | M        | O     | O    | O     | 41          | 3216   |
| R256     | 200k   | 5%         | 1/8   | C    | M        | O     | O    | O     | 41          | 3216   |
| R257     | 200k   | 5%         | 1/8   | C    | M        | O     | O    | O     | 41          | 3216   |
| R258     | 200k   | 5%         | 1/8   | C    | M        | O     | O    | O     | 41          | 3216   |
| R259     | 200k   | 5%         | 1/8   | C    | M        | O     | O    | O     | 41          | 3216   |
| R260     | 200k   | 5%         | 1/8   | C    | M        | O     | O    | O     | 41          | 3216   |
| R261     | 200k   | 5%         | 1/8   | C    | M        | O     | O    | O     | 41          | 3216   |
| R262     | 200k   | 5%         | 1/8   | C    | M        | O     | O    | O     | 41          | 3216   |
| R263     | 200k   | 5%         | 1/8   | C    | M        | O     | O    | O     | 41          | 3216   |
| R264     | 200k   | 5%         | 1/8   | C    | M        | O     | O    | O     | 41          | 3216   |
| R265     | 200k   | 5%         | 1/8   | C    | M        | O     | O    | O     | 41          | 3216   |
| R266     | 200k   | 5%         | 1/8   | C    | M        | O     | O    | O     | 41          | 3216   |
| R267     | 200k   | 5%         | 1/8   | C    | M        | O     | O    | O     | 41          | 3216   |
| R268     | 200k   | 5%         | 1/8   | C    | M        | O     | O    | O     | 41          | 3216   |
| R269     | 200k   | 5%         | 1/8   | C    | M        | O     | O    | O     | 41          | 3216   |
| R270     | 200k   | 5%         | 1/8   | C    | M        | O     | O    | O     | 41          | 3216   |
| R271     | 200k   | 5%         | 1/8   | C    | M        | O     | O    | O     | 41          | 3216   |
| R272     | 200k   | 5%         | 1/8   | C    | M        | O     | O    | O     | 41          | 3216   |
| R273     | 200k   | 5%         | 1/8   | C    | M        | O     | O    | O     | 41          | 3216   |
| R274     | 200k   | 5%         | 1/8   | C    | M        | O     | O    | O     | 41          | 3216   |
| R275     | 200k   | 5%         | 1/8   | C    | M        | O     | O    | O     | 41          | 3216   |
| R276     | 200k   | 5%         | 1/8   | C    | M        | O     | O    | O     | 41          | 3216   |
| R277     | 200k   | 5%         | 1/8   | C    | M        | O     | O    | O     | 41          | 3216   |
| R278     | 200k   | 5%         | 1/8   | C    | M        | O     | O    | O     | 41          | 3216   |
| R279     | 200k   | 5%         | 1/8   | C    | M        | O     | O    | O     | 41          | 3216   |
| R280     | 200k   | 5%         | 1/8   | C    | M        | O     | O    | O     | 41          | 3216   |
| R281     | 200k   | 5%         | 1/8   | C    | M        | O     | O    | O     | 41          | 3216   |
| R282     | 200k   | 5%         | 1/8   | C    | M        | O     | O    | O     | 41          | 3216   |
| R283     | 200k   | 5%         | 1/8   | C    | M        | O     | O    | O     | 41          | 3216   |
| R284     | 200k   | 5%         | 1/8   | C    | M        | O     | O    | O     | 41          | 3216   |
| R285     | 200k   | 5%         | 1/8   | C    | M        | O     | O    | O     | 41          | 3216   |
| R286     | 200k   | 5%         | 1/8   | C    | M        | O     | O    | O     | 41          | 3216   |
| R287     | 200k   | 5%         | 1/8   | C    | M        | O     | O    | O     | 41          | 3216   |
| R288     | 200k   | 5%         | 1/8   | C    | M        | O     | O    | O     | 41          | 3216   |
| R289     | 200k   | 5%         | 1/8   | C    | M        | O     | O    | O     | 41          | 3216   |
| R290     | 200k   | 5%         | 1/8   | C    | M        | O     | O    | O     | 41          | 3216   |
| R291     | 200k   | 5%         | 1/8   | C    | M        | O     | O    | O     | 41          | 3216   |
| R292     | 200k   | 5%         | 1/8   | C    | M        | O     | O    | O     | 41          | 3216   |
| R293     | 200k   | 5%         | 1/8   | C    | M        | O     | O    | O     | 41          | 3216   |
| R294     | 200k   | 5%         | 1/8   | C    | M        | O     | O    | O     | 41          | 3216   |
| R295     | 200k   | 5%         | 1/8   | C    | M        | O     | O    | O     | 41          | 3216   |
| R296     | 200k   | 5%         | 1/8   | C    | M        | O     | O    | O     | 41          | 3216   |
| R297     | 200k   | 5%         | 1/8   | C    | M        | O     | O    | O     | 41          | 3216   |
| R298     | 200k   | 5%         | 1/8   | C    | M        | O     | O    | O     | 41          | 3216   |
| R299     | 200k   | 5%         | 1/8   | C    | M        | O     | O    | O     | 41          | 3216   |
| R300     | 200k   | 5%         | 1/8   | C    | M        | O     | O    | O     | 41          | 3216   |

### Display Board

# PRINTED BOARD LOCATION DAIGARM

## P.W.B MAIN

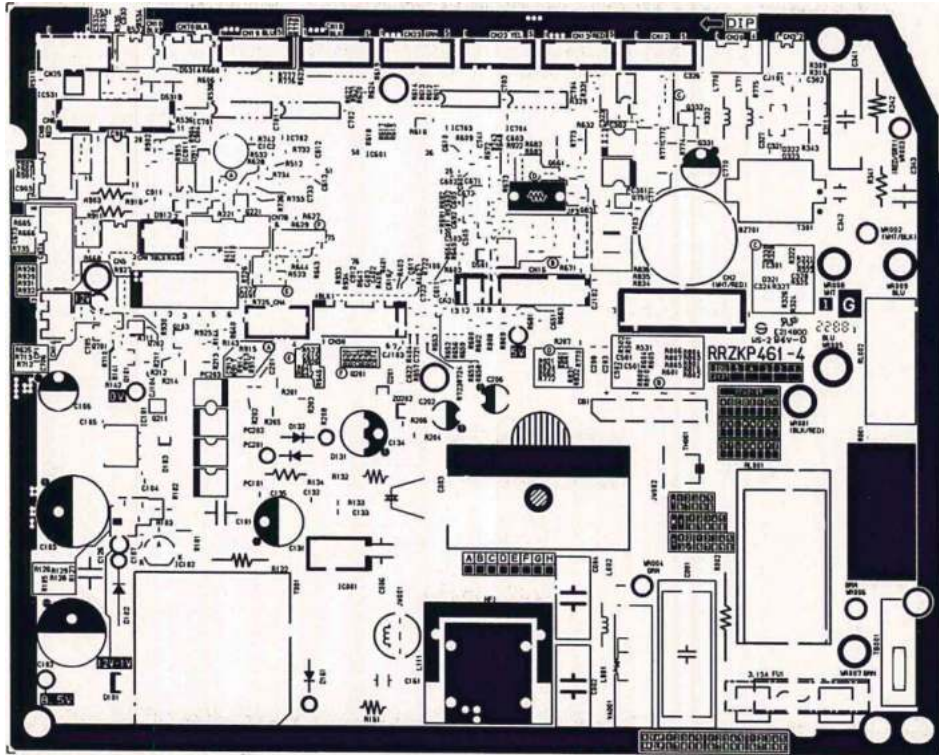

## P.W.B RECEIVER

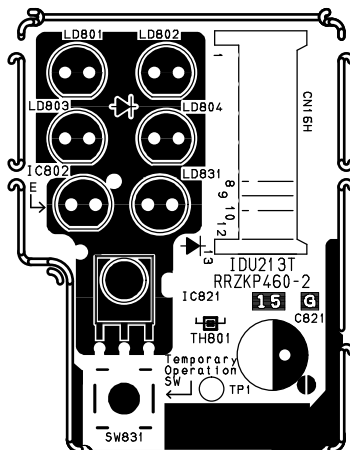

BLOCK DIAGRAM  
MODEL RAK-DJ24PHAA

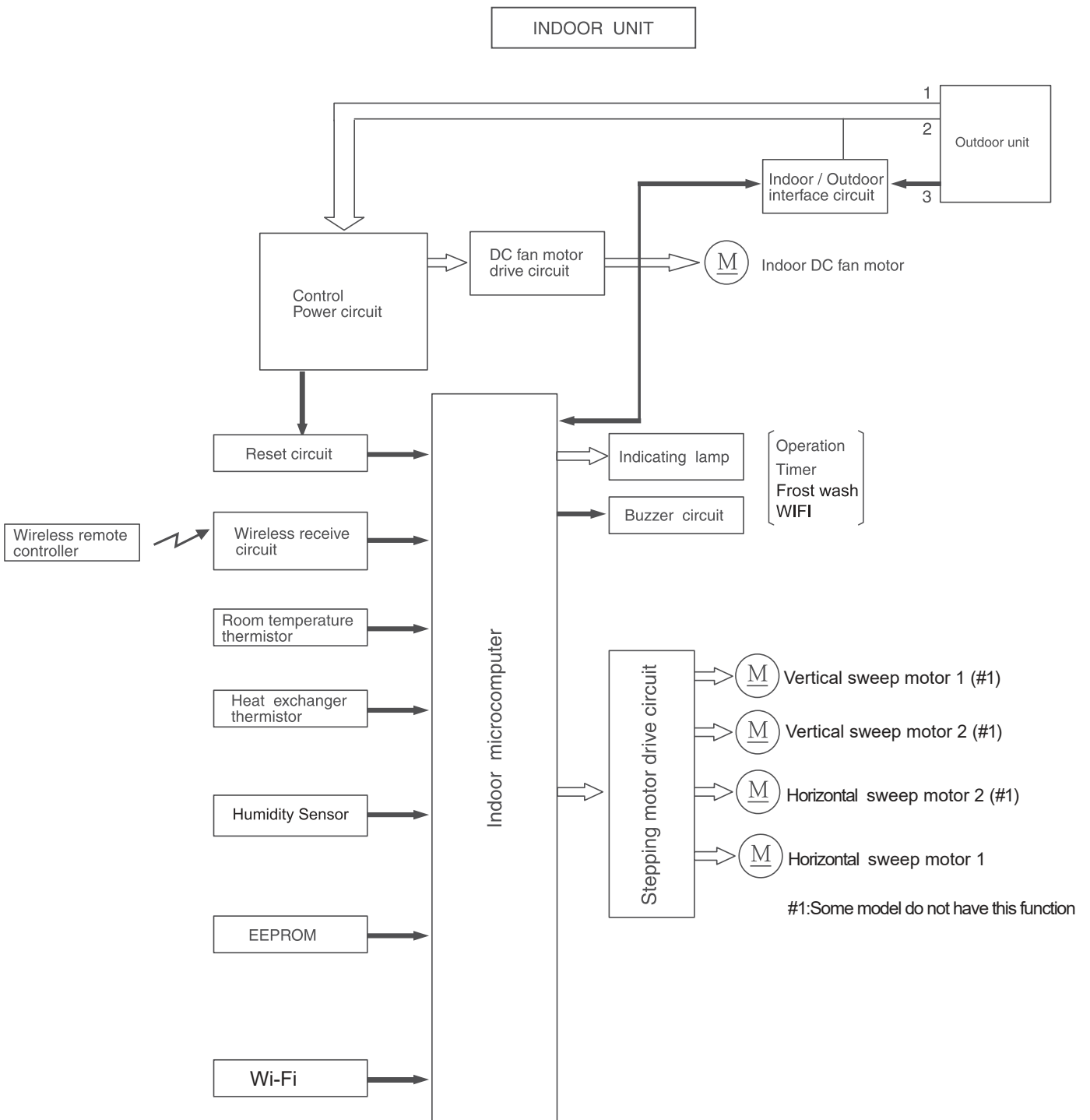

# BASIC MODE

MODEL RAK-DJ24PHAA

| Operation mode                            | Fan  | Cooling  | Dry  | Heating  | Auto   |  |
|---|--|--|--|--|--|--|
| Basic operation of start/stop button      |  |  |  |  |  |  |
| Timer functions                           | Off-timer  |  |  |  |  |  |
|   | On-timer   |  |  |  |  |  |
|   | Off -> On<br>On -> Off timer   |  |  |  |  |  |
| Fan speed mode (indoor fan)               | Auto   | <p>Changes from "Hi" to "Med" or "Lo" depending on room temperature.</p> <p>1. Runs at "Hi" until room temperature reaches to "setting temperature-SFTDSC" after operation is started.<br/>2. Runs at "ultra-Lo" when thermo is off.</p> |  | <p>Set to "ultra-Lo", "Silent", "Lo", "Med", "Hi", "ultra-Hi" or "stop" depending on the room temperature, time and heat exchanger temperature. Set to "stop" if the heat exchanger temperature is "DNZKOF" during Thermo OFF.(When reach at "DNZKON", fan speed set to "ultra-Lo" again.)</p> <p>In modes other than left</p> | <p>Operating mode is judged by room temperature.</p> <p>(1) Judging by room temperature</p> <ul style="list-style-type: none"> <li>Operating mode at start up is judged (initial judgment).</li> <li>(a) Conditions for judgment (any of the followings). <ul style="list-style-type: none"> <li>When auto operation is started after the previous auto mode operation.</li> <li>When auto operation is started after the previous manual mode operation.</li> <li>When the operating mode is switched to auto while operating at manual mode.</li> </ul> </li> <li>(b) Judging method <ul style="list-style-type: none"> <li>[ Cooling ] : Room temperature <math>\geq</math> Remote controller setting</li> <li>[ Heating ] : Room temperature <math>&lt;</math> Remote controller setting</li> </ul> </li> </ul> <p>(2) Judging operating mode change during operation (Continuous judgment).</p> <p>(a) Conditions for judgment</p> <ul style="list-style-type: none"> <li>The mode is reviewed at interval time.</li> <li>Interval time as below <ul style="list-style-type: none"> <li>The first interval time : 10 minutes</li> <li>The second interval time : 15 minutes</li> <li>On and after the third interval time : 55 minutes</li> </ul> </li> </ul> <p>(b) Judging method</p> <ul style="list-style-type: none"> <li>Judge by setting the hysteresis on the final preset temperature.</li> <li>The final preset temperature is the actually targeted preset temperature which is sum of basic preset temperature and each type of shift value.</li> </ul> <p>(e.g. preset temperature correction value, powerful shift value, eco shift value, eco sleep shift value, etc.)</p> <p>[ Currently cooling ]</p> <ul style="list-style-type: none"> <li>Room temperature <math>\leq</math> Final preset temperature <math>-5.4^{\circ}\text{F} (-3^{\circ}\text{C})</math> Change to heating</li> <li>Room temperature <math>&gt;</math> Final preset temperature <math>-5.4^{\circ}\text{F} (-3^{\circ}\text{C})</math> Continue cooling</li> </ul> <p>[ Currently heating ]</p> <ul style="list-style-type: none"> <li>Room temperature <math>\geq</math> Final preset temperature <math>+2^{\circ}\text{C}</math> Change to cooling</li> <li>Room temperature <math>&lt;</math> Final preset temperature <math>+2^{\circ}\text{C}</math> Continue heating</li> </ul> |  |
|   | Super Hi   | Operates at "Super Hi" regardless of the room temperature.   | Set to "ultra-Hi" when the compressor runs at cold dash mode speed, and to "Super Hi" in other modes. Runs at "ultra-Lo" when thermo is off. |  | <p>Set to "ultra-Lo", "Silent", "Lo", "Med", "Hi", "Super Hi", "ultra-Hi" or "stop" depending on the room temperature, time and heat exchanger temperature. Set to "stop" if the heat exchanger temperature is "DNZKOF" during Thermo OFF.(When reach at "DNZKON", fan speed set to "ultra-Lo" again.)</p> <p>Set to "ultra-Hi" when the compressor is running at maximum speed during hot dash or when recovered from defrosting.</p>   |  |
|   | Hi   | Operates at "Hi" regardless of the room temperature.   | Set to "ultra-Hi" when the compressor runs at cold dash mode speed, and to "Hi" in other modes. Runs at "ultra-Lo" when thermo is off.       |  | <p>Set to "ultra-Lo", "Silent", "Lo", "Med", "Hi", "ultra-Hi" or "stop" depending on the room temperature, time and heat exchanger temperature. Set to "stop" if the heat exchanger temperature is "DNZKOF" during Thermo OFF.(When reach at "DNZKON", fan speed set to "ultra-Lo" again.)</p>   |  |
|   | Med  | Operates at "Med" regardless of the room temperature.  | Operates at "Med" regardless of the room temperature. Runs at "ultra-Lo" when thermo is off.   |  | <p>Set to "ultra-Lo", "Silent", "Lo", "Med", "Hi", "ultra-Hi" or "stop" depending on the room temperature, time and heat exchanger temperature. Set to "stop" if the heat exchanger temperature is "DNZKOF" during Thermo OFF.(When reach at "DNZKON", fan speed set to "ultra-Lo" again.)</p>   |  |
|   | Lo   | Operates at "Lo" regardless of the room temperature.   | Operates at "Lo" regardless of the room temperature. Runs at "ultra-Lo" when thermo is off.  | Set to "Lo" in modes other than when the compressor stops.   | <p>Set to "ultra-Lo", "Silent", "Lo", "Med", "Hi", "ultra-Hi" or "stop" depending on the room temperature, time and heat exchanger temperature. Set to "stop" if the heat exchanger temperature is "DNZKOF" during Thermo OFF.(When reach at "DNZKON", fan speed set to "ultra-Lo" again.) The fan speed is controlled by the heat exchanger temperature; the overload control is executed as in the following diagram:</p>  |  |
|   | Silent   | Operates at "Silent" regardless of the room temperature.   | Operates at "Silent" regardless of the room temperature. Runs at "ultra-Lo" when thermo is off.  | Set to "Silent" in modes other than when the compressor stops.   |  |  |
| Basic operation of temperature controller | Performs only fan operation at the set speed regardless of the room temperature. | See page 29.   | See page 31.   | See page 33.   |  |  |

## Basic Cooling Operation

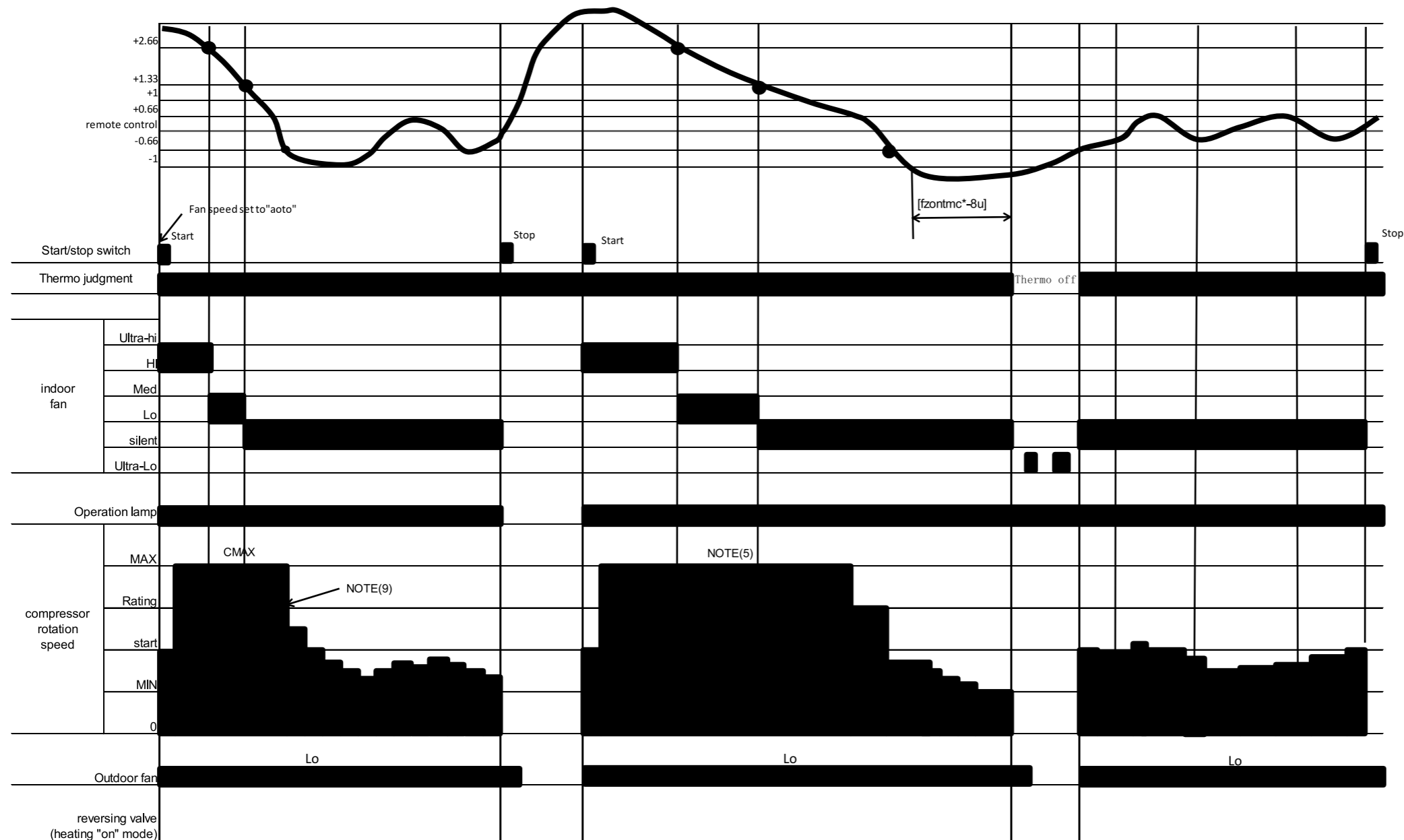

### Notes:

- (1) Condition for entering into Cool Dashed mode. When fan set to "Hi" or "Auto and when the compressor speed (P section) due to temperature difference between setting temperature (including the correction shift only) and room temperature is CMAX or higher.
- (2) Cool Dashed will release when i) a maximum 25 minutes is lapsed and ii) room temperature is lower than set temperature 5.4°F (-3°C) (thermo off) and iii) when room temperature has achieved setting temperature -sftdsc then maximum Cool Dashed time will be revised to 20 minutes. And iv) indoor fan is set to Lo and Med fan mode and v) change operation mode.
- (3) During Cool Dashed operation, thermo off temperature is set temperature (with shift value) 5.4°F (-3°C). After thermo off, operation continue in Fuzzy control mode.
- (4) Compressor minimum "ON" time and "OFF" time is 3 minutes.
- (5) During normal cooling mode, compressor maximum rpm CMAX will maintain for 60 minutes if indoor temperature is lower than 54°F (30°C). No time constrain if indoor temperature is higher than CLMXTP.
- (6) When fan is set to "Hi", compressor rpm will be limited to CSTD.
- (7) When fan is set to "Med", compressor rpm will be limited to CJKMAX.
- (8) When fan is set to "Lo", compressor rpm will be limited to CBEMAX.
- (9) During Cool Dashed, when room temperature reaches set temperature -sftdsc\_8U compressor rpm is actual rpm x 70%.



## Cooling Defrost

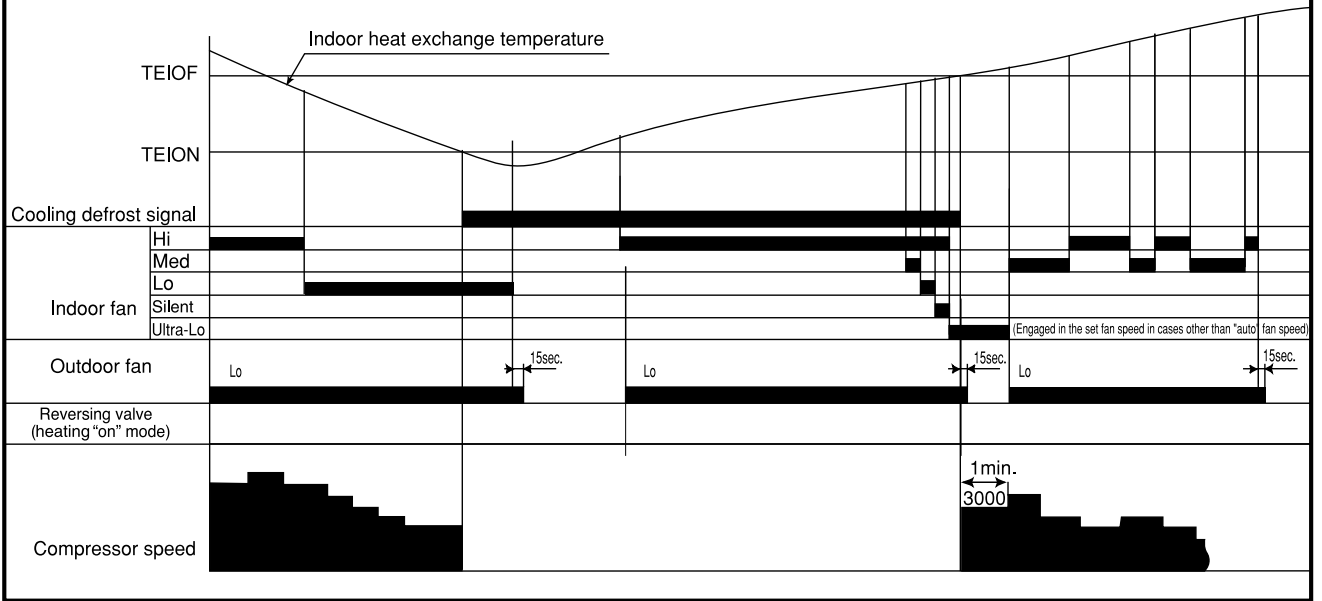

## Cooling Powerful Operation

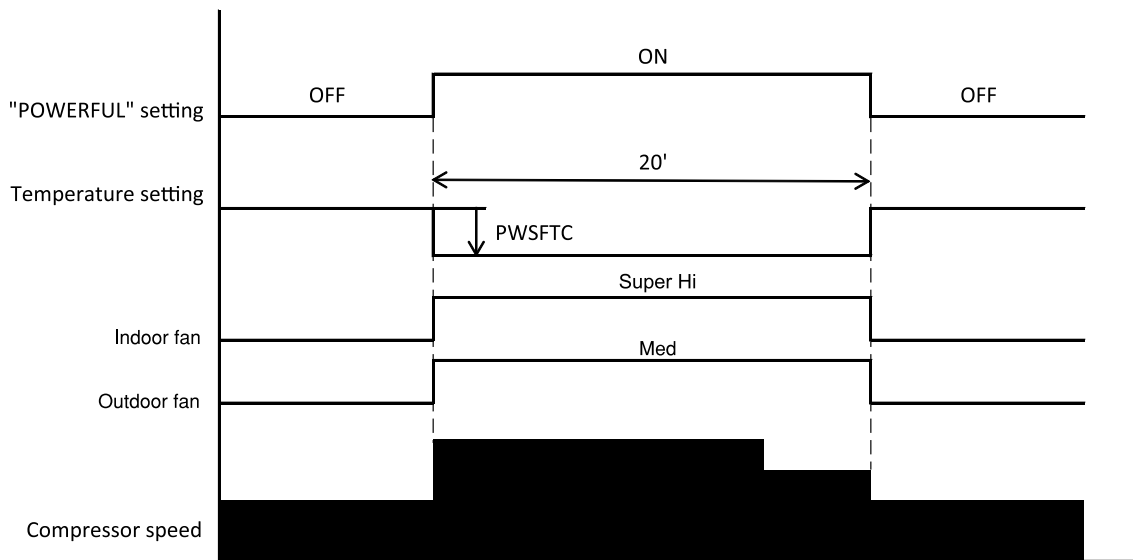

**Notes :**

- (1) Pressing the "POWERFUL" button will reduce the temperature setting by PWSFTC 3.6°F (2°C).
- (2) The powerful operation is for 20 minutes after setting.
- (3) Operation is continued forcibly thermo-ON for 20 minutes after the powerful operation is finished.
- (4) Pressing the "START/STOP" button and "POWERFUL" button during powerful operation will cancel the powerful operation.
- (5) If the GoodSleep timer is set during powerful operation, the powerful operation will be canceled.
- (6) When the powerful operation is set, the fan speed will be set to "Super Hi" and the compressor's maximum speed will be set to CMAX2 during powerful operation. The compressor's lower limit speed is CKYMIN\_PW.
- (7) The fan speed increases by FNUPPW\_C.
- (8) After the powerful operation is ended, the system automatically operates with the previous settings used before the powerful operation.

# Dry

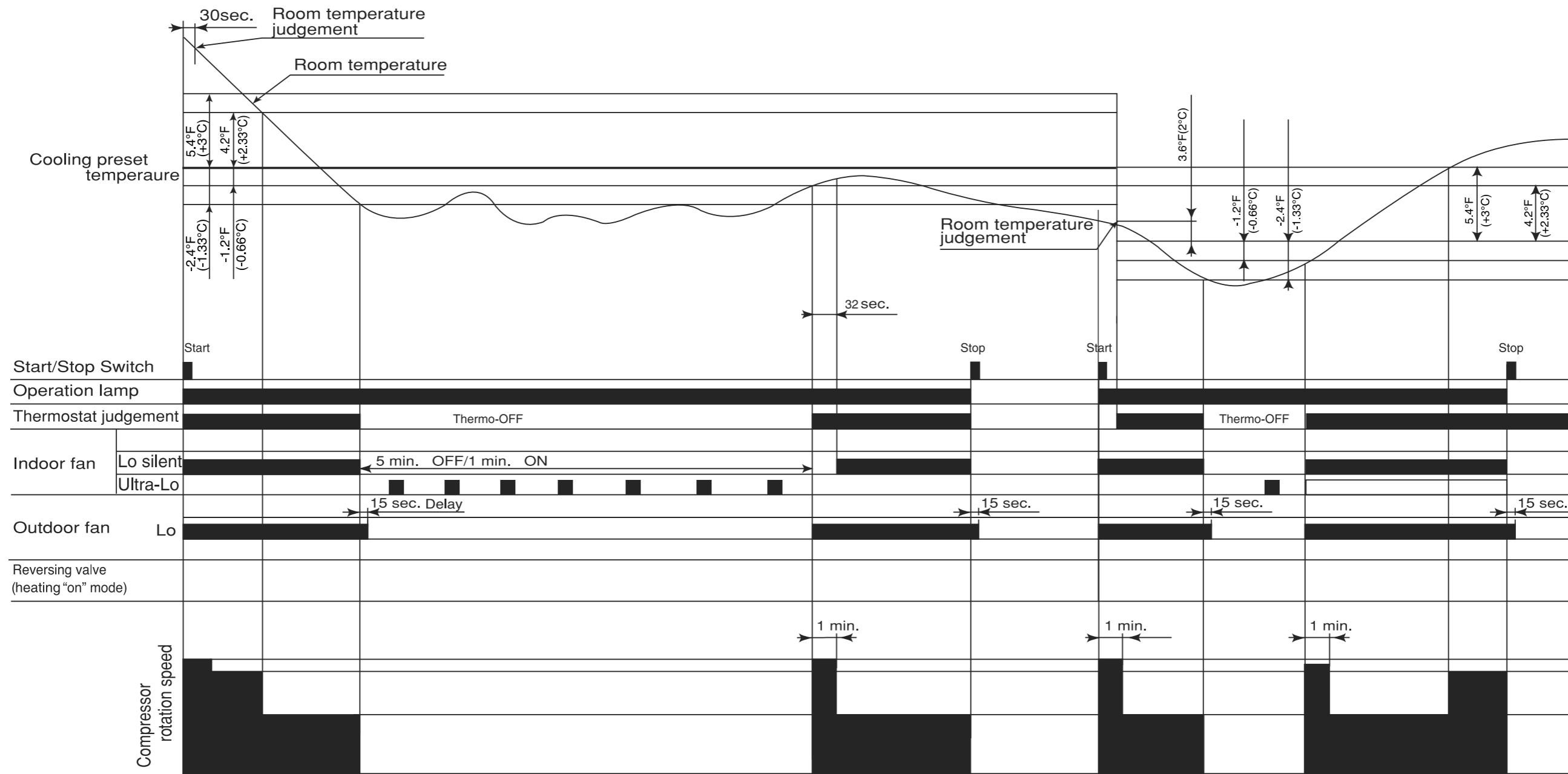

**Notes:**

- (1) If the room temperature is (cooling preset temperature) - 2.4°F (-1.33°C) or less after 30 seconds from starting the operation, the operation is done assuming as the preset temperature = (room temperature at the time) - 3.6°F (2°C).
- (2) The indoor fan is operated in the "Lo" mode. During thermo OFF indoor fan will be OFF for 5 minutes and ON for 1 minute.
- (3) When the operation is started by the thermostat turning ON, the start of the indoor fan is delayed 32 seconds after the start of compressor operation.
- (4) The compressor is operated forcedly for 3 minutes after operation is started.
- (5) The minimum ON time and OFF time of the compressor are 3 minutes.

## Dry Powerful Operation

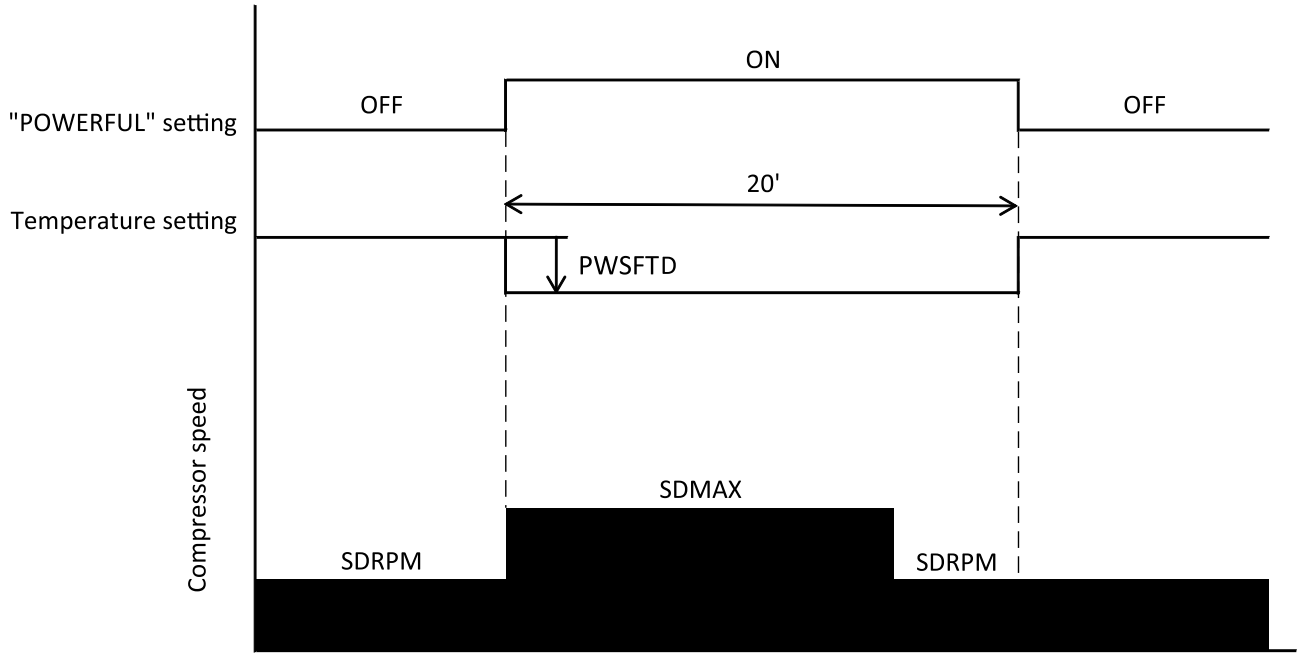

**Notes :**

- (1) Pressing the "POWERFUL" button will reduce the temperature setting by PWSFTSD.
- (2) The powerful operation is for 20 minutes after setting.
- (3) Operation is continued forcibly thermo-ON for 20 minutes after the powerful operation is finished.
- (4) Pressing the "START/STOP" button and "POWERFUL" button during powerful operation will cancel the powerful operation.
- (5) If the GoodSleep Timer is set during powerful operation, the powerful operation will be canceled.
- (6) If the differential (the room temperature - the temperature setting) is "the differential  $\geq 5.4^{\circ}\text{F}$  ( $+3^{\circ}\text{C}$ ) after powerful setting, the compressor's maximum speed during powerful operation will be set to SDMAX. Then the differential reduce "the differential  $\cong 4.2^{\circ}\text{F}$  ( $2.33^{\circ}\text{C}$ ) during powerful operation, the compressor's speed will be set to SDRPM.  
If the differential (the room temperature - the temperature setting) is "the differential  $< 5.4^{\circ}\text{F}$  ( $+3^{\circ}\text{C}$ ) after powerful setting, the compressor's minimum speed during powerful operation will be set to SDRPM.
- (7) After the powerful operation is ended, the system automatically operates with the previous settings used before the powerful operation.

## Basic Heating Operation

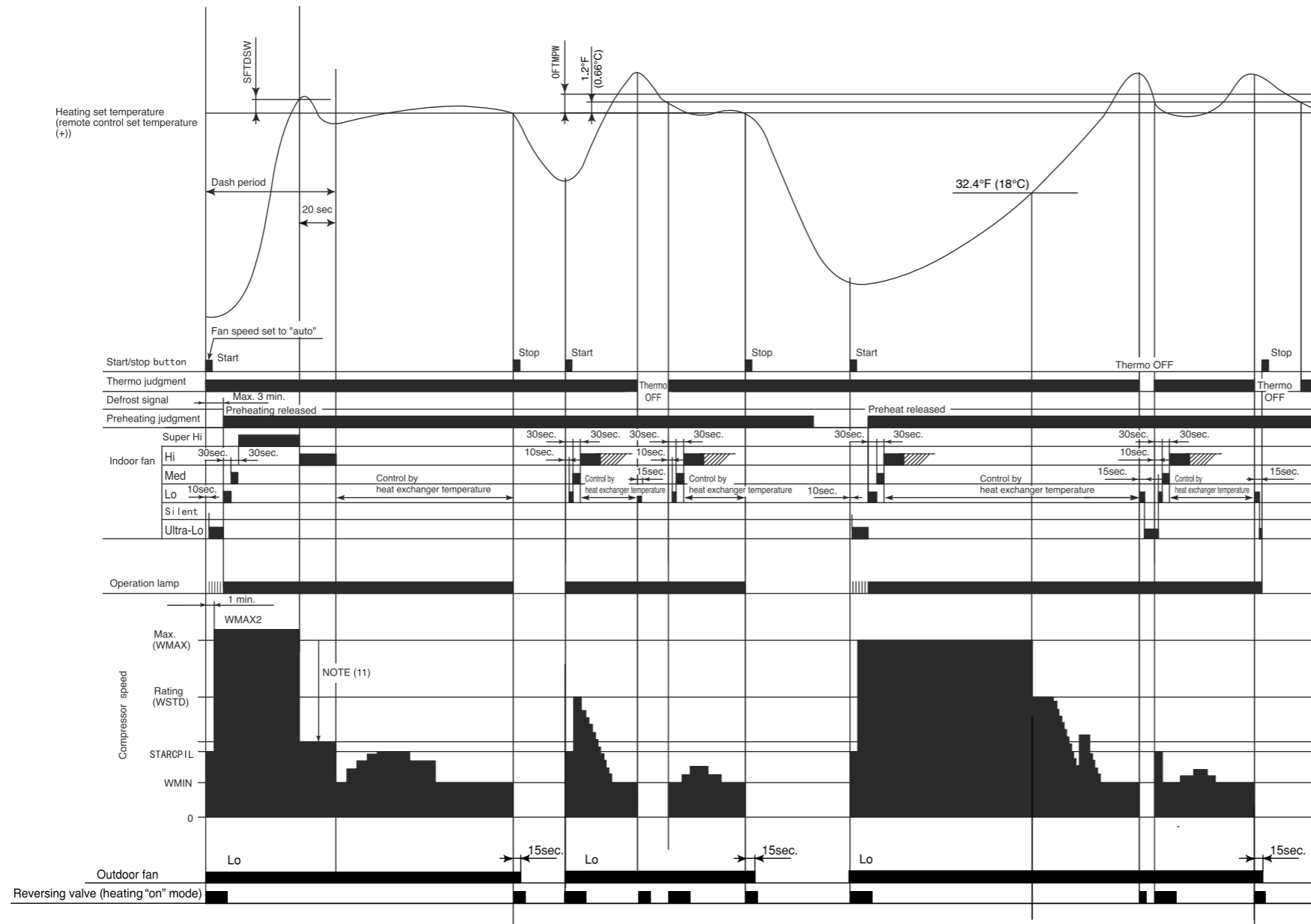

**Notes:**

- (1) Condition for entering into hot dashed mode. When fan set to "Hi" or "Auto" and i) room temperature is 18 or less, and ii) outdoor temperature is 10 or less, and iii) compressor speed (P section) due to temperature difference between setting temperature(including shift value only) and room temperature is WMAX or more.
- (2) The maximum compressor speed period during hot dash is finished when i) room temperature has reached the setting temperature + SFTDSW. ii) thermo off.
- (3) During hot dashed operation, thermo off temperature is setting temperature (with shift value) +3 . After thermo off, operation continue inn Fuzzy control mode.
- (4) Minimum "ON" time and minimum "OFF" time of compressor operation is 3 minutes.
- (5) During normal heating mode, compressor maximum rpm WMAX will maintain for 120 minutes. No time limit constrain if room temperature is 18 or less and outdoor temperature is 2 or less.
- (6) During preheating or defrosting or auto fresh defrosting mode, indoor unit operation lamp will blink.
- (7) When heating mode starts, it will enter into preheating mode if indoor heat exchanger temperature is less than YNEOF + 0.33 .
- (8) When fan is set to "Med" or "Lo" or "Silent", compressor rpm will be limited to "WJKMAX" or "WBEMAX" or "WSZMAX".
- (9) During "Ultra-Lo" mode, if room temperature is 18 or less, indoor fan will stop. If room temperature is  $18 + 0.33$  or more, fan will continue in "Ultra-Lo" mode. However, "Ultra-Lo" mode during preheating or preheating after defrosting does not stop if room temperature is 18 or less.
- (10) During hot dashed or outdoor temperature is -5 or less, compressor rpm is WMAX2.
- (11) During hot dashed, when room temperature reaches setting temperature + SFTDSW compressor rpm is actual rpm x DWNRATEW.

## Setting Defrosting Inhibit Period

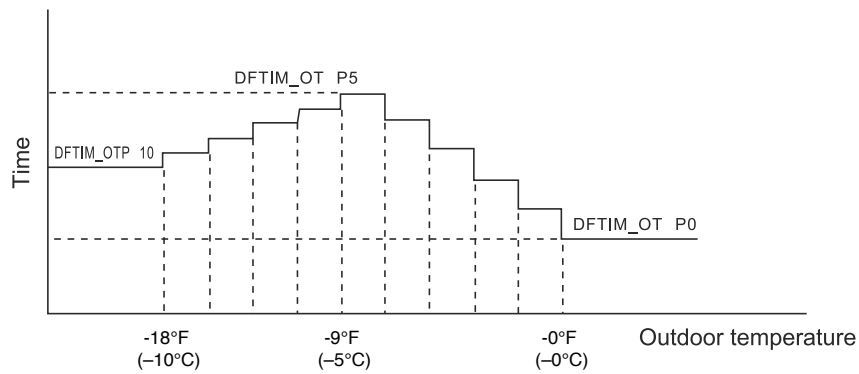

### Notes:

- (1) The first inhibit time after operation start is set to DFTIM\_FST.
- (2) From the second time onwards, the inhibit time is set according to the time required for defrosting.  
Reverse cycle operation time  $\geq$  [DEFCOL] : DEFTIM\_COL is set.  
Reverse cycle operation time  $<$  [DEFCOL] : The time corresponding to outdoor temperature is set.

## Heating Powerful Operation

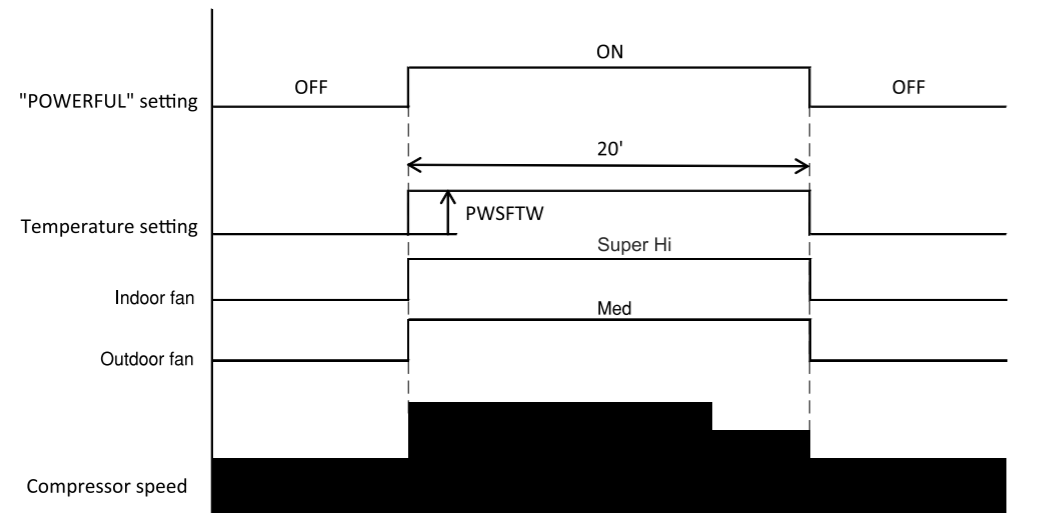

### Notes :

- (1) Pressing the "POWERFUL" button will increase the temperature setting by PWSFTW.
- (2) The powerful operation is for 20 minutes after setting.
- (3) Operation is continued forcibly thermo-ON for 20 minutes after the powerful operation is finished.
- (4) Defrost is inhibited for 20 minutes after the start of the powerful operation.
- (5) Pressing the "START/STOP" button and "POWERFUL" button during powerful operation will cancel the powerful operation.
- (6) If the GoodSleep timer is set during powerful operation, the powerful operation will be canceled.
- (7) When the powerful operation is set, the fan speed will be set to "HIGH" and the compressor's maximum speed will be set to WMAX2 during powerful operation. The compressor's lower limit speed is WKYMIN\_PW.
- (8) After the powerful operation is ended, the system automatically operates with the previous settings used before the powerful operation.

## Leave Home

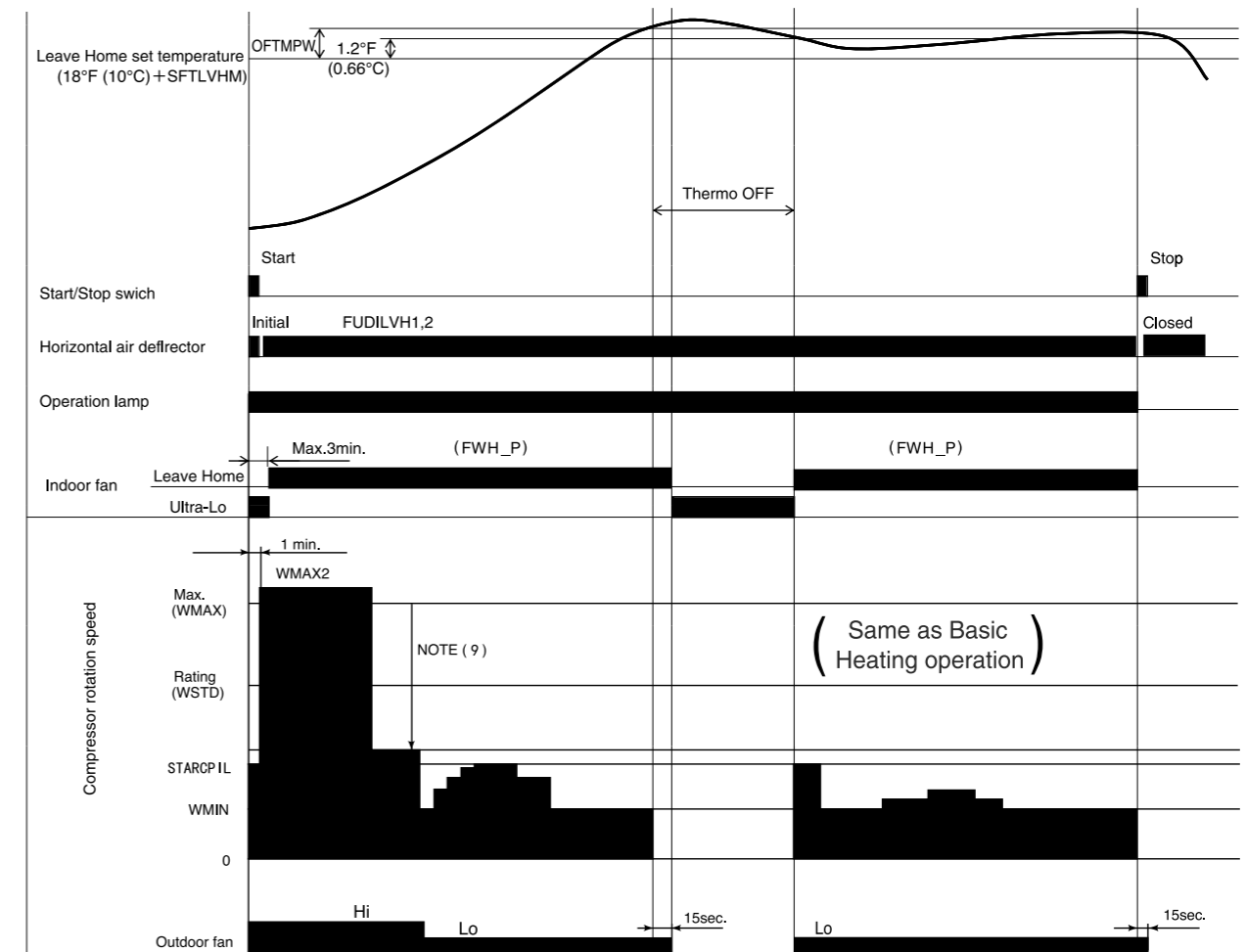

### Notes:

Perform Leave Home operation according to the following control contents.

- (1) Operation mode : Heating
- (2) Temperature set : 18°F (10°C) ~ 16°F (28.8°C)
- (3) Temperature setting correction shift : + 『SFTLVHM』
- (4) Indoor fan : 『FWH\_P』
- (5) Outdoor fan speed :
- (6) Compressor start control : } Same as Basic Heating operation
- (7) Compressor speed :
- (8) Lamp indication : i) Operation lamp : ON  
ii) Timer lamp : OFF( Continuous operation ) ; ON( Day timer operation )

# ECO

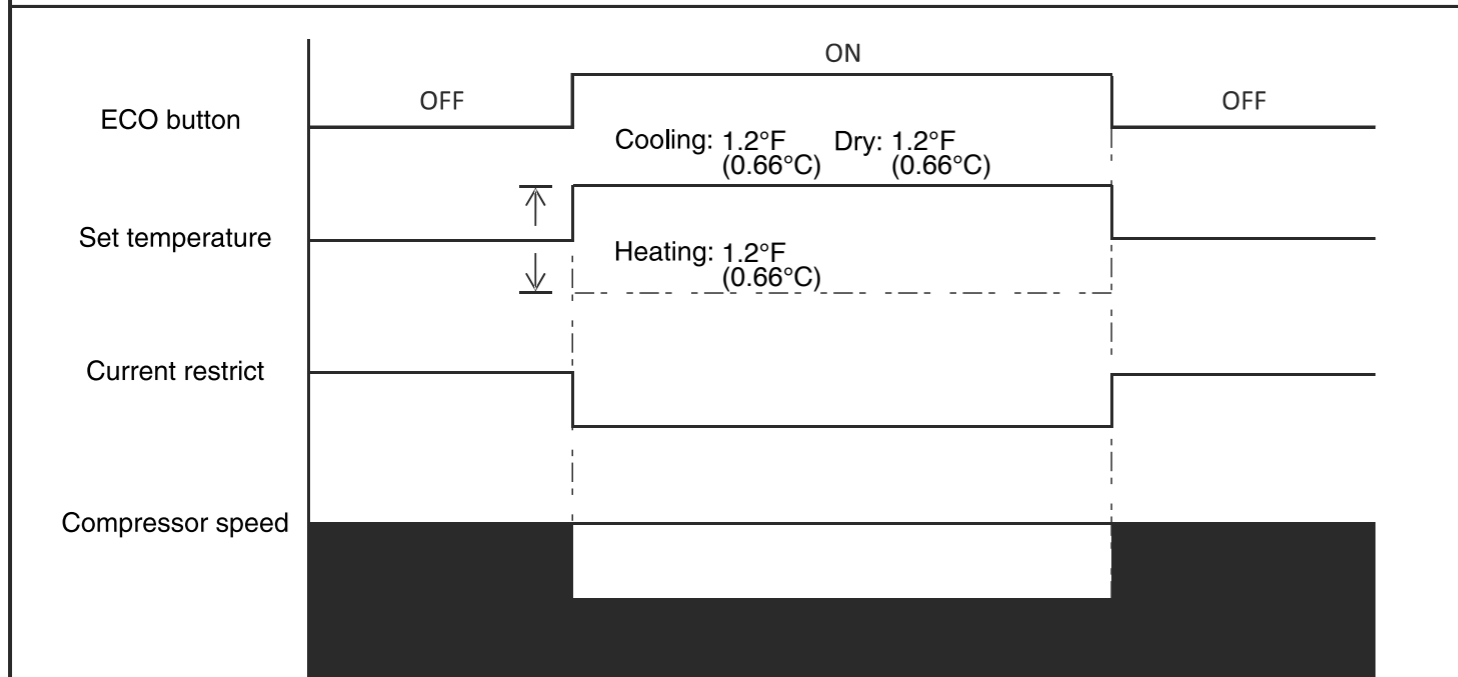

**Notes:**

- Can't set POWERFUL and ECO at the same time.
- During FAN operation, can't set ECO.

# Reversing valve defrosting

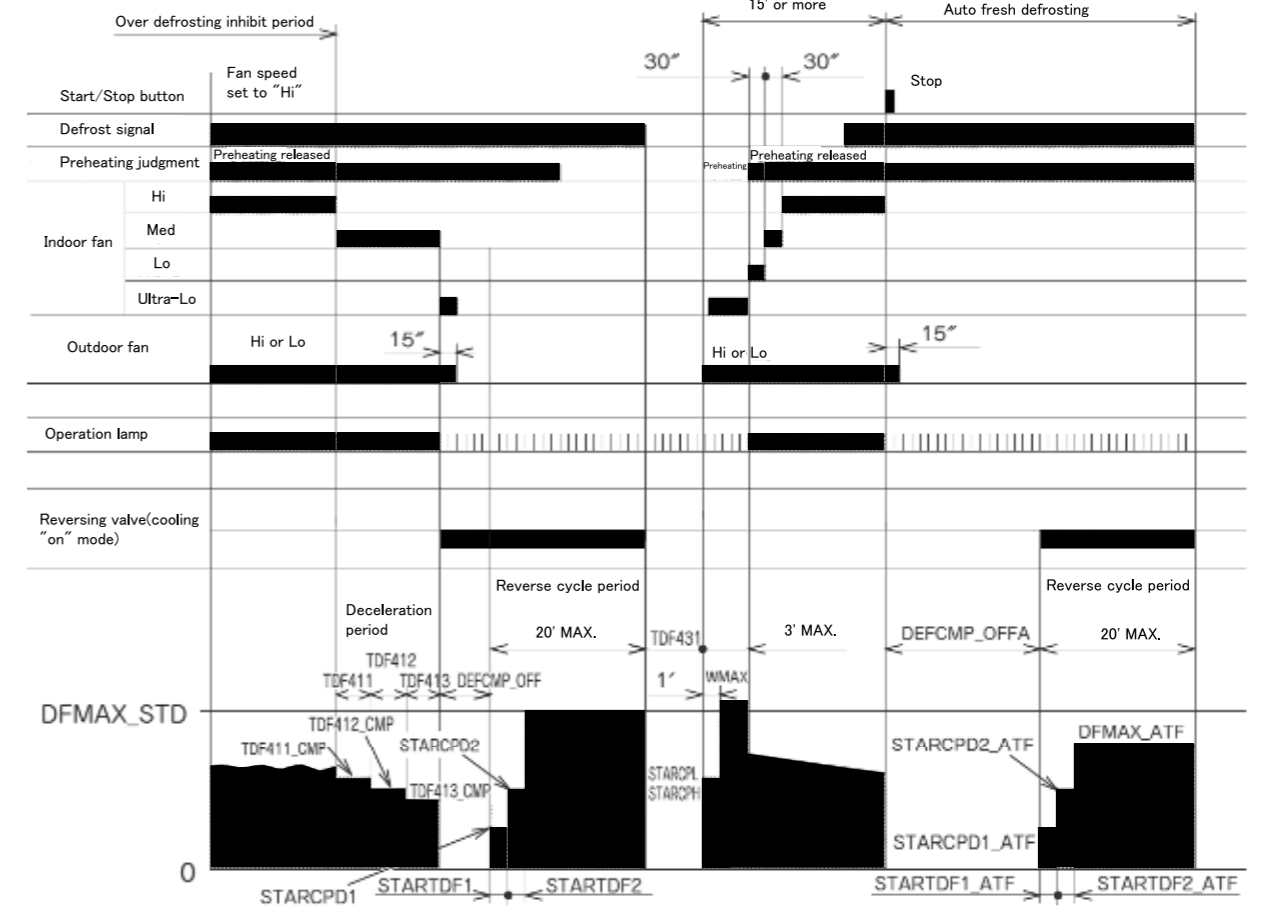

**Notes:**

- (1) The defrosting inhibit period is set as shown in the diagram above. When defrosting has finished once, the inhibit period is newly set, based on the outdoor temperature when the compressor was started. During this period, the defrost signal is not accepted.
- (2) If the difference between the room and outdoor temperature is large when defrosting is finished, the maximum compressor speed (WMAX) or (WMAX2) can be continued for 120 minutes maximum.
- (3) The defrosting period is 20 minutes maximum.
- (4) When operation is stopped during defrosting, it is switched to auto refresh defrosting.
- (5) Auto refresh defrosting cannot be engaged within 15 minutes after operation is started or defrosting is finished.

# Frost wash

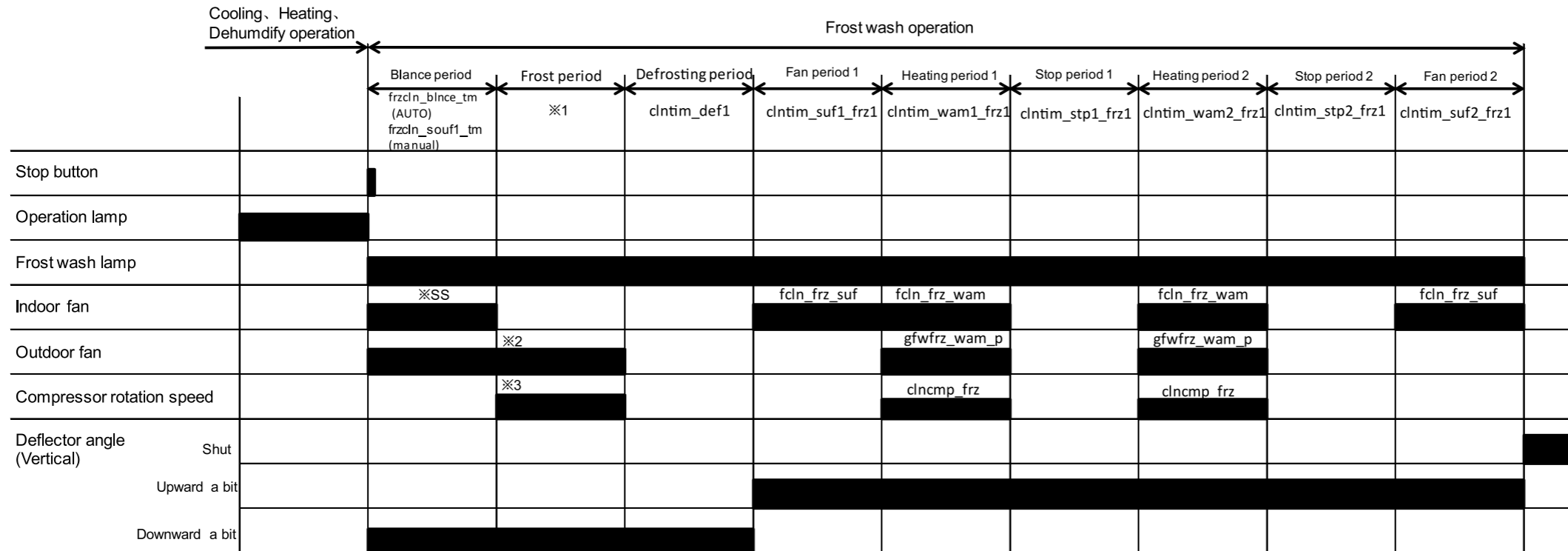

- (1) The total hours of air conditioning operation is more than 42 hours(SLEEP、ON TIMER operation will take 84 hours ) ,And air conditioner is operated for more than 30 minutes, Meanwhile, the outdoor temperature and indoor humidity are suitable for the Frost Wash(Area A、B in Fig.3、4),Frost Wash (auto) start;
  - (2) Within 2 hours before the ON TIMER designated time,Frost wash(auto) cannot be operate;
  - (3) ONCE TIMER (ON/OFF TIMER) operation cannot be set ,when Frost wash(auto) is running;
  - (4) When the Frost Wash is stopped during Frost Wash operation, the unit automatically restart Frost Wash at the next operation stop.
  - (5) Before the Frost period start,the outdoor temperature  $\geq 28.8^{\circ}\text{F}$  ( $16^{\circ}\text{C}$ ), Or before the defrosting period finish, the heat exchanger temperature  $\geq 0^{\circ}\text{F}$  ( $0^{\circ}\text{C}$ ), The Heating period will not running. Fan period 1 ~ Fan Period 2 all turn to Fan operation
  - (6) In frost period ,The maximum time is 10 minutes after the heat exchanger temperature  $\leq -18^{\circ}\text{F}$  ( $-10^{\circ}\text{C}$ )
  - (7) Heating period will finish after the heat exchanger temperature  $\geq 63^{\circ}\text{F}$  ( $35^{\circ}\text{C}$ ), remanent time turn to Fan period 2, the total time unchanged
  - (8) Fan period 1~ Fan period 2 will not running,when last operation was HEATING;
  - (9) When device operat Frost wash during ON condition,the device will stop and have blance time(3 minutes)
  - (10) Before the Frost period start,OH temperature  $\geq 108^{\circ}\text{F}$  ( $60^{\circ}\text{C}$ ), Original balance period time will add 3 minutes
- ※1 According to room humidity, the Frost period time becomes as it is shown in Fig.1.  
 ※2 According to Compressor rotation speed, the Outdoor fan becomes as it is shown in Fig.2.  
 ※3 The Compressor rotation speed becomes as it is shown in Fig.5.about area A,  
 The Compressor rotation speed becomes as it is shown in Fig.6.about area B

Fig.1 Frost Period time

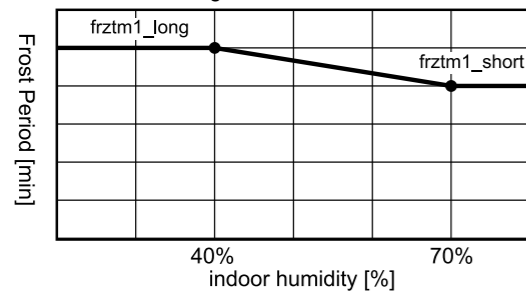

Fig.2 Frost Period outdoor Fan

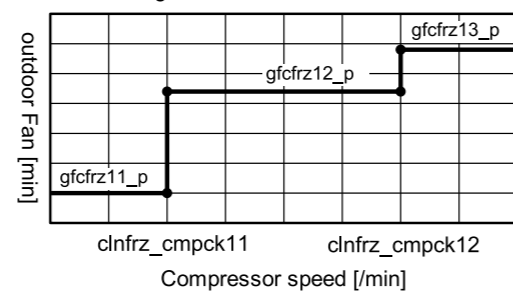

Fig.3 The range of indoor/outdoor temperature

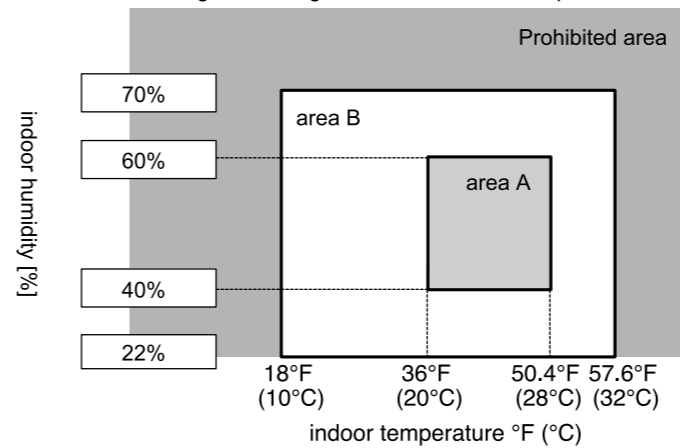

Fig.4 The range of indoor/outdoor temperature

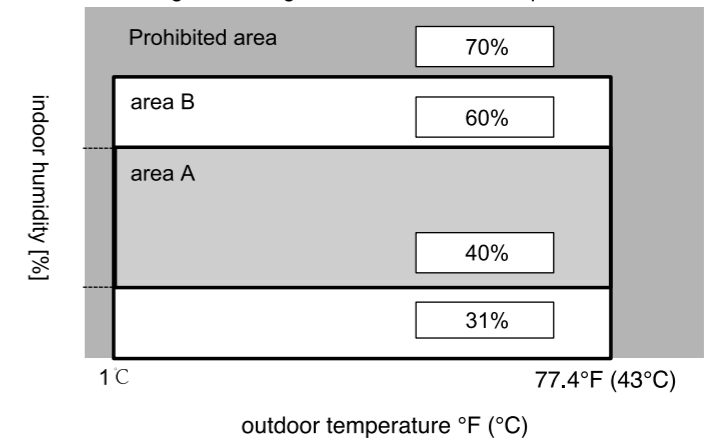

Fig.5 Frost Period Compressor speed (area A)

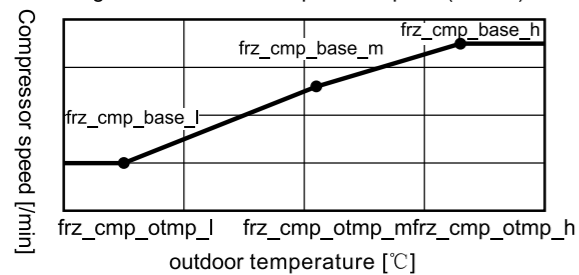
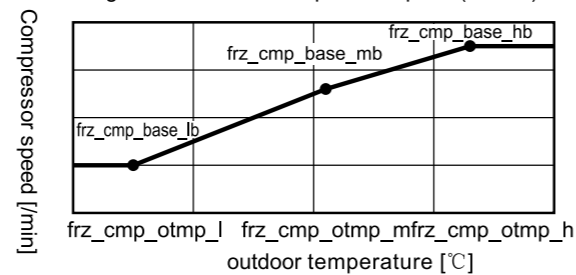

Fig.6 Frost Period Compressor speed (area B)





# REFRIGERATING CYCLE DIAGRAM

COOLING, DEHUMIDIFYING, DEFROSTING

Refrigerant flow →

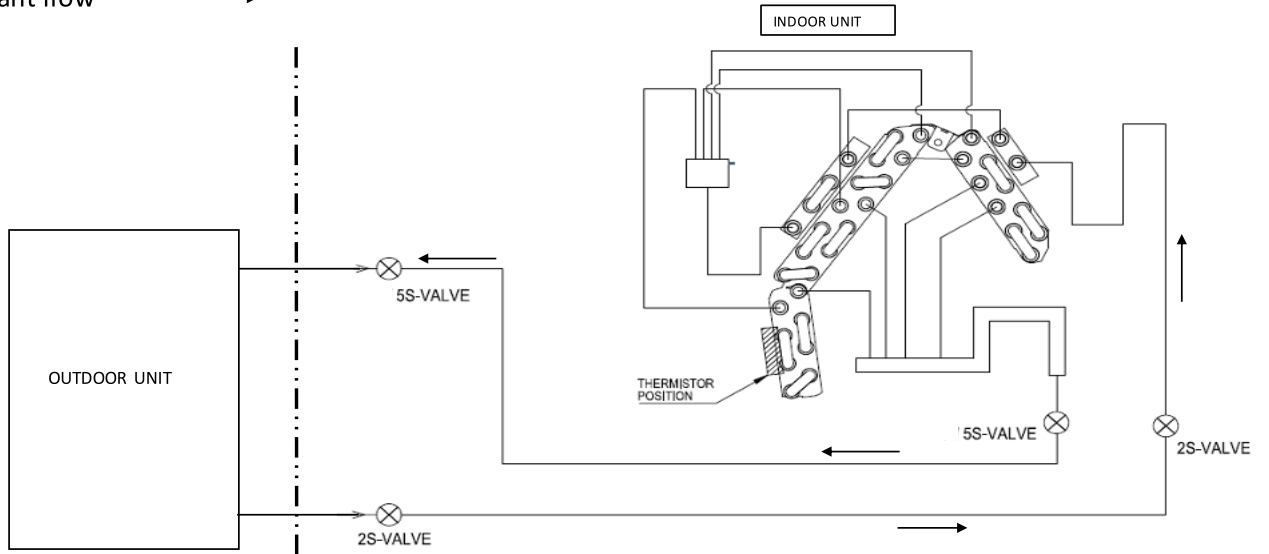

HEATING

Refrigerant flow - - - - -

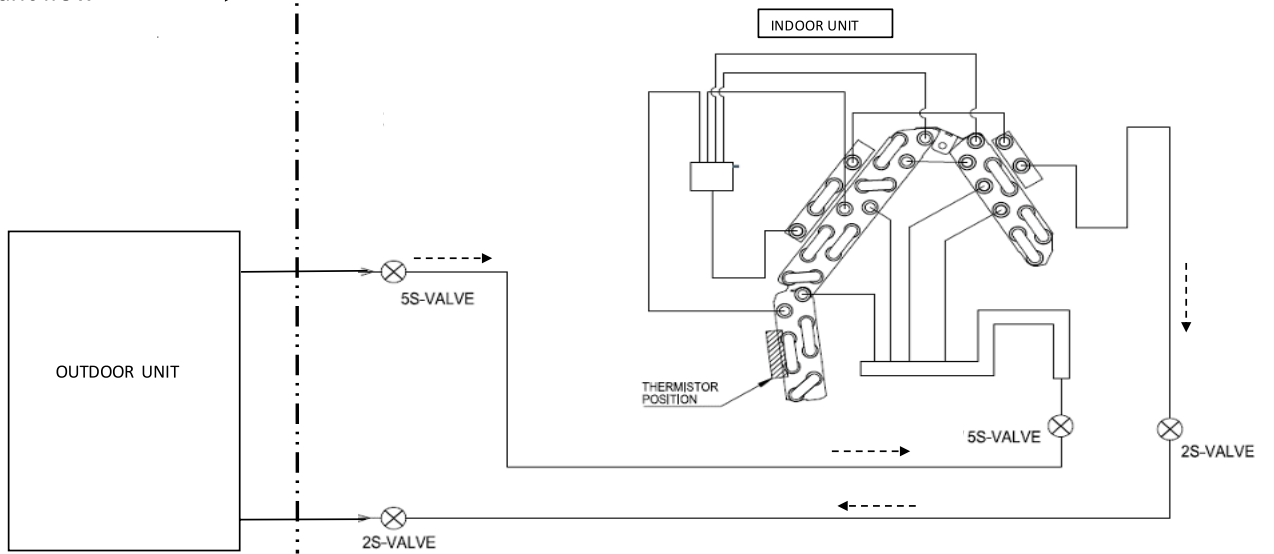

# Procedure for Disassembly and Reassembly

INDOOR UNIT RAK-DJ24PHAA

## 1. Front Panel

Be sure to hold the front panel with both hands to detach and attach it.

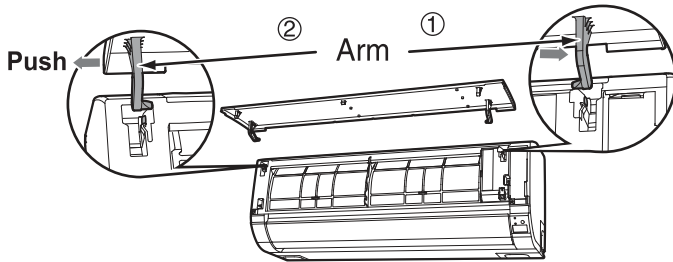

Fig. 1

1. Push the end of the right-side arm outward to release the tab.
2. Move the left-side arm outward to release the left tab, and then pull the panel towards you.

## 2. Front cover

- (1) After removing the screw of fixing the terminal cover, hold the handle of terminal cover and remove it.
- (2) After removing two screws, pull the center of the front cover forward and release the claws.
- (3) Hold the front cover at both lower sides and pull them forward to remove.

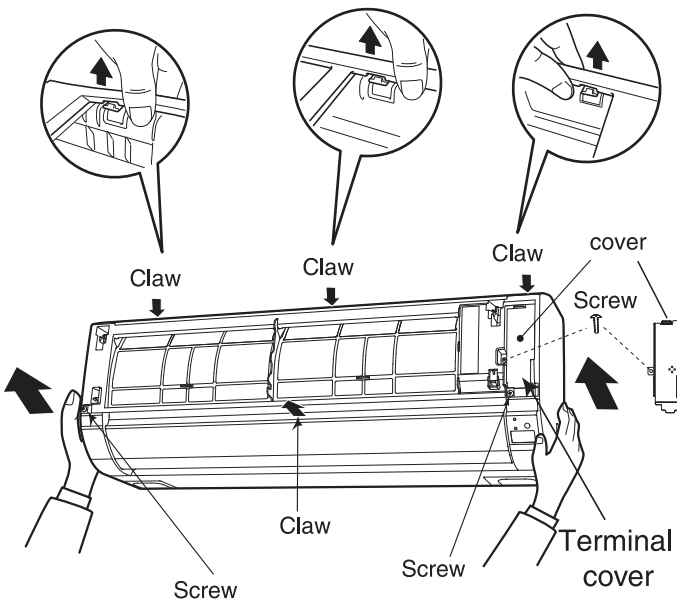

Fig. 2

## 3. Control P.W.B. and Indicating P.W.B.

- (1) Remove each connector from the lead wire.
- (2) Remove the four P.W.B. supports from the control P.W.B.

- (3) Pull the support hook at the upper side of the indication lamp of the indicating P.W.B. and pull out the P.W.B. forward.

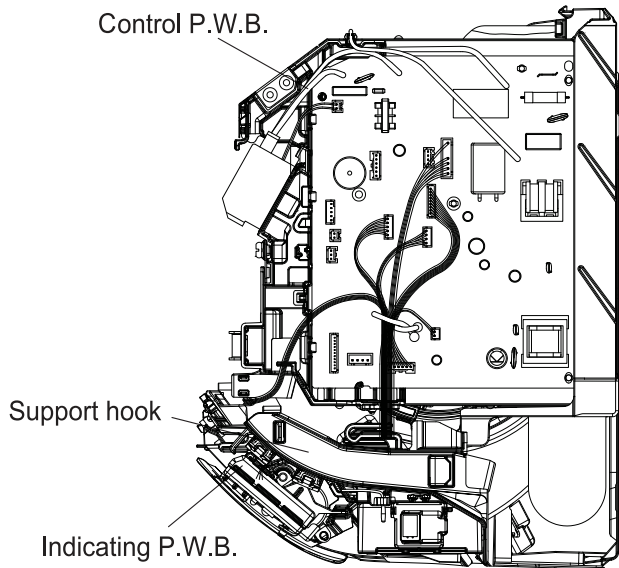

Fig. 3

## 4. Tangential air flow fan and fan motor

- (1) Loosen the fan lock screw.

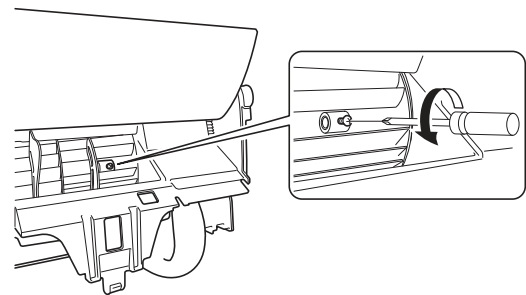

Fig. 4

- (2) Press the fan motor cover 2 fixed pawl, and remove from the right to.

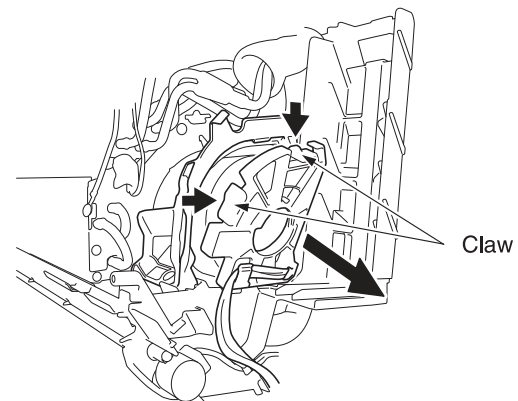

Fig. 5

(3) Pull fan motor out of the remove the right.

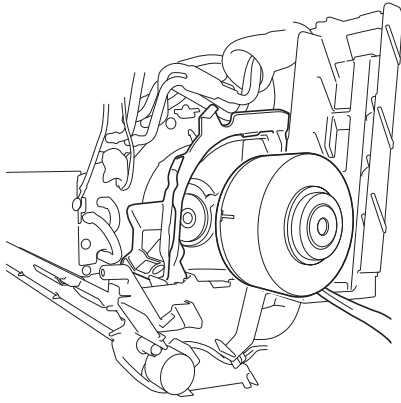

Fig. 6

- (4) Remove the screws from the upper and lower bearing covers.
- (5) Remove the locking hook of the lower bearing cover from the Cabinet.

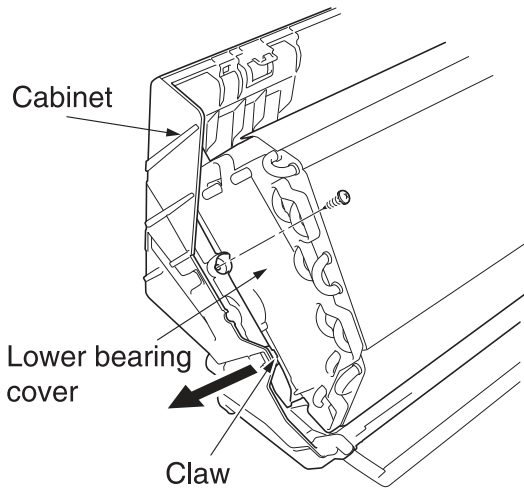

Fig. 7

(6) Remove the fan and bearing from the left.

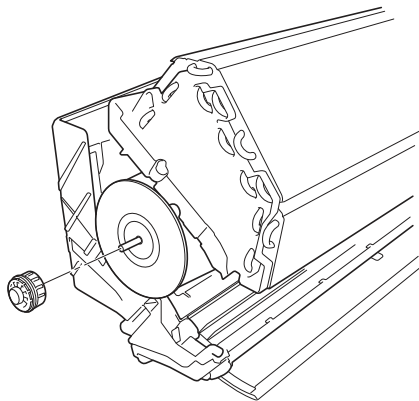

Fig. 8

**Points for attention of fan motor and tangential air flow fan installation.**

When installing the flow fan, the first part of the fan and water seal plate on the tube plate overlap, then tighten the screw.

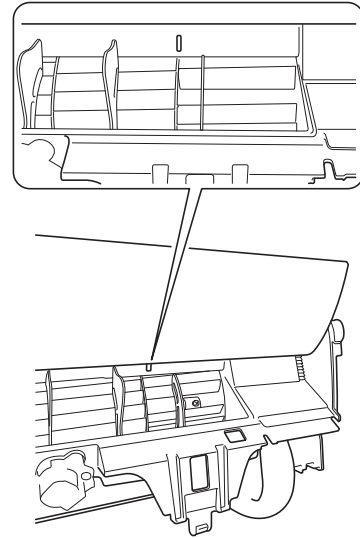

Fig. 9

**5. Stepping motor**

- (1) The FC-guide frame fixed claw right side press. Remove the FC-guide from the rear.

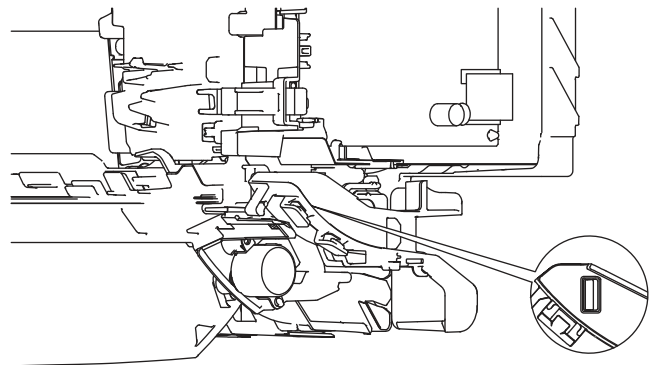

Fig. 10

- (2) Remove the stepping motor screws and take off the stepping motor.

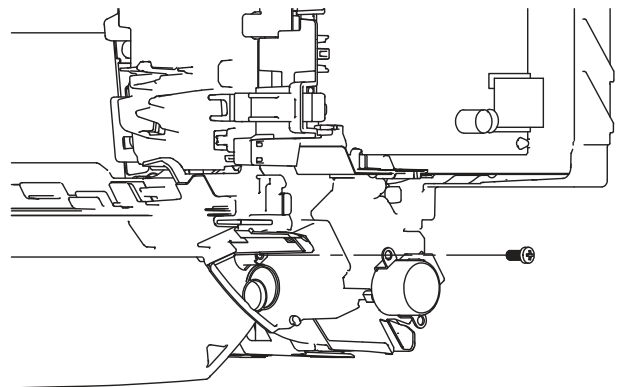

Fig. 11

# DESCRIPTION OF MAIN CIRCUIT OPERATION

MODEL RAK-DJ24PHAA

## 1. Control power circuit

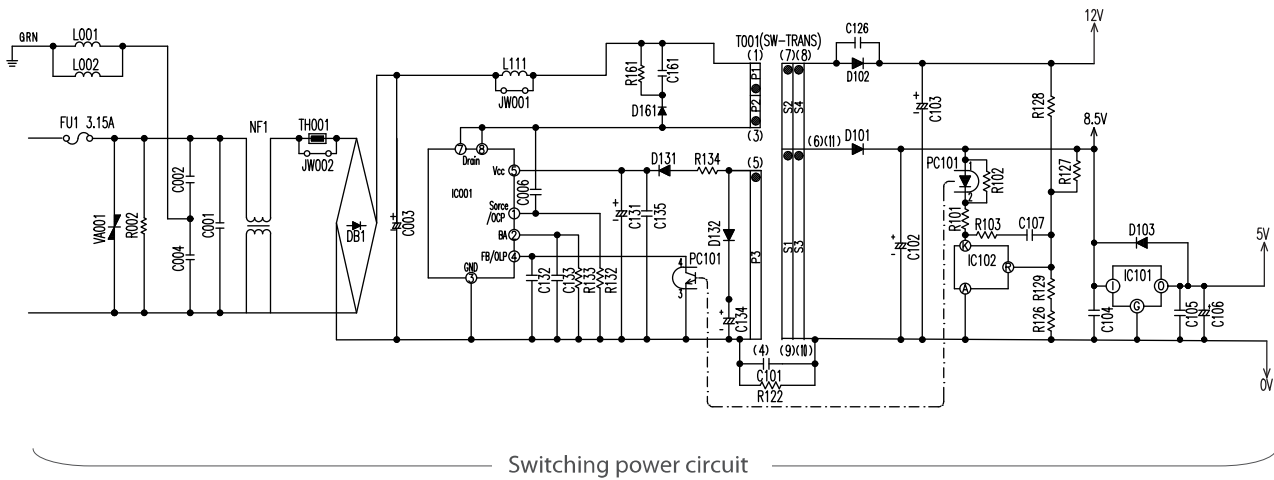

Fig.1-1

- An AC power supply from indoor unit passes through the 3.15A fuse, varistor (VA001), and noise filter circuit and rectified and smoothed by DB1 and C003 to become a DC current 325 V. It is then supplied to indoor fan motor drive circuit, and switching power circuit.
- The switching power circuit, as controlled by IC001, drives the primary winding of the transformer (T001) to produce a specified voltage at the output winding. [The output terminal (pin ⑤) of IC001 has a switching voltage. But it changes in voltage peak and oscillation period depending on the power load. usually, the oscillation frequency when the air condition operation is about 64.5 kHz. In the standby state, the oscillation frequency is lowered to a level as low as 64.5 kHz or so to reduce the standby power.]
- The outputs of the output windings of the transformer is rectified and smoothed to become DC voltages at primary 18.5 V, 12 V, and 8.5 V respectively. The primary 18.5 V is supplied to the drive circuit of the indoor fan motor, the 12 V is supplied to each vane motor and to the drive circuits of the cleaning unit driving motor and other equipment, and the 8.5 V is adjusted to a stable 5 V by IC101 and supplied to the microcomputer peripheral circuit.

### Check

If a failure in a part or circuit has produced an abnormal current in the power supply, the 3.15A fuse will melt down to prevent further damage. If the 3.15A fuse melts down, check the indoor fan motor, switching electrical circuit, and other components and replace any defective part.

### Check

If an abnormally high voltage is applied to the power supply, the 3.15A fuse and varistor (VA001) will prevent further damage. If a high voltage results in the 3.15A fuse melted down, the varistor (VA001) should have deteriorated and destroyed. Therefore replace it at the same time.

### Caution

The primary circuit of the transformer (T001) has a voltage to ground. Guard against electric shocks.

## 2 . Stepping motor drive circuit

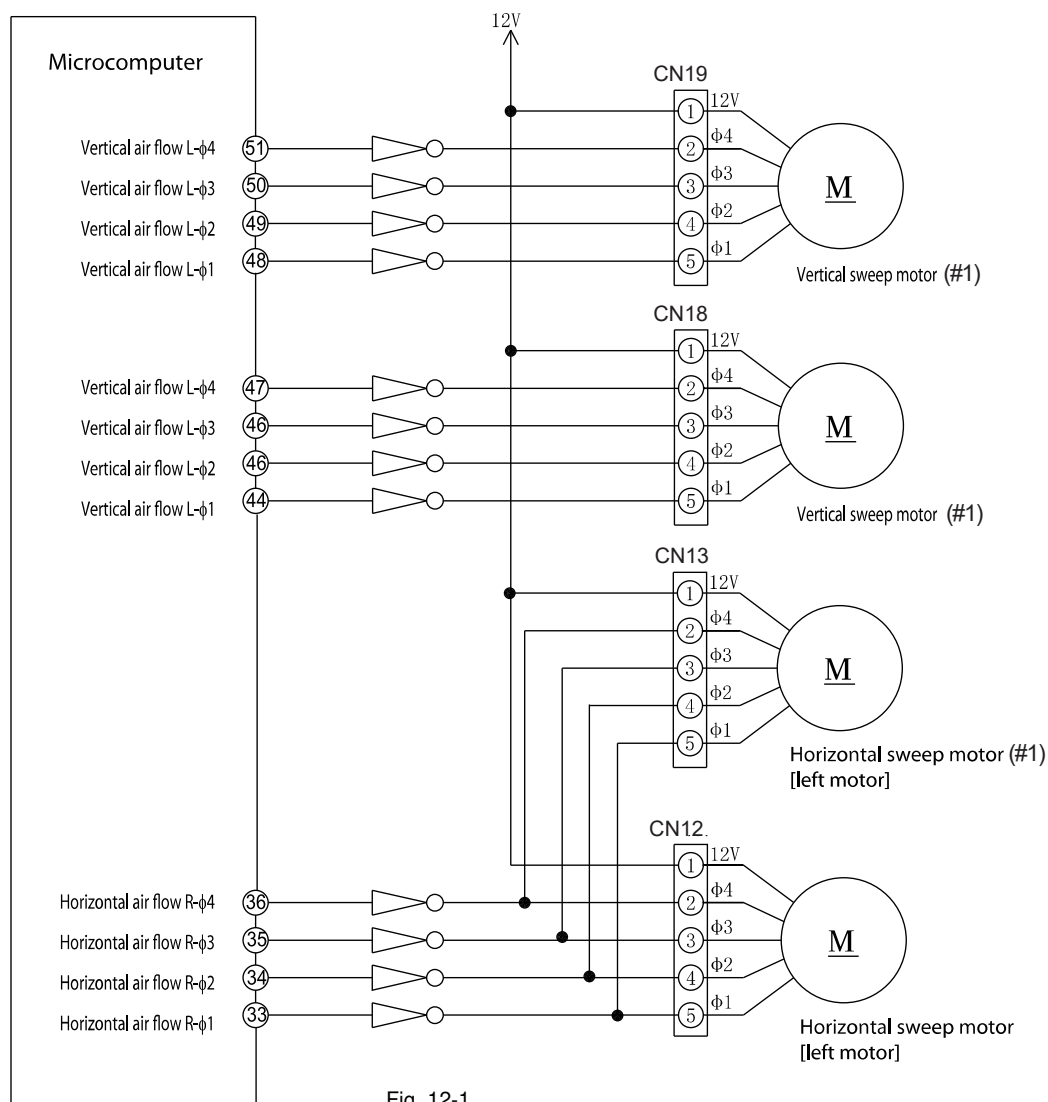

Fig. 12-1

#1:Some model do not have this function

[Connector circuit waveform while the motor runs]

Voltage waveforms of different phases as viewed from the OV line while the motor rotor is turning counterclockwise as viewed from the shaft side

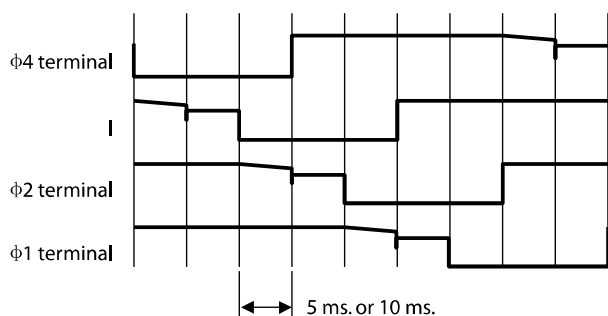

Fig. 12-2

- Each stepping motor runs as excited in 1 or 2 phases at 100 PPS or 200 PPS.
- The excitation pattern passes the microcomputer (IC601) and then the driver IC and excites the coil of each stepping motor.
- Some models not need to install the horizontal sweep motor.

### 3. Drive circuit of the indoor fan motor

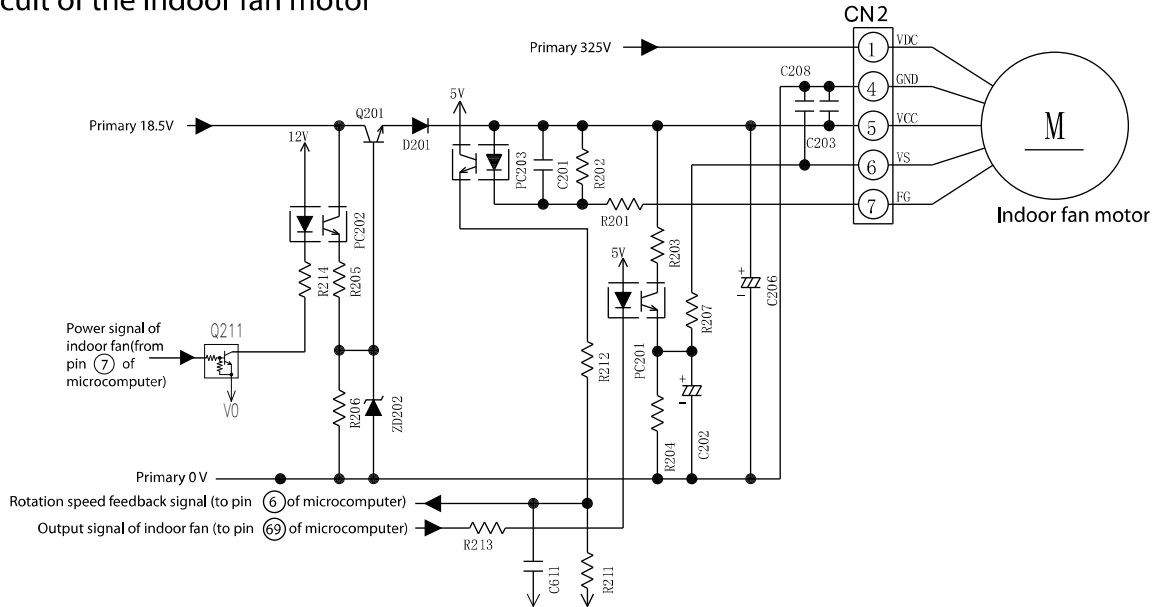
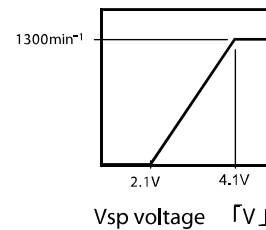

Fig. 3-1

< The circuit check (For test) >

| Name                       | Test point       | Test voltage |
|----------------------------|------------------|--------------|
| Motor drive power          | CN2 ① pin- ④ pin | About 325V   |
| Motor control power        | CN2 ⑤ pin- ④ pin | About 15V    |
| Motor speed signal         | CN2 ⑥ pin- ④ pin | About 2-6V   |
| Motor rotation speed debug | CN2 ⑦ pin- ④ pin | About 7.5V   |

< Pin 6 - Pin 4 voltage one example >



\* The different mode maybe have different FAN rotation speed.

\* The voltage above is all motor operation vol. when you start the test, take care of your connector, do not touch the different pin together.

\* The voltage of pin ⑥ - pin ④, pin ⑦ - ④ maybe different from above.

< Typical circuit waveform >

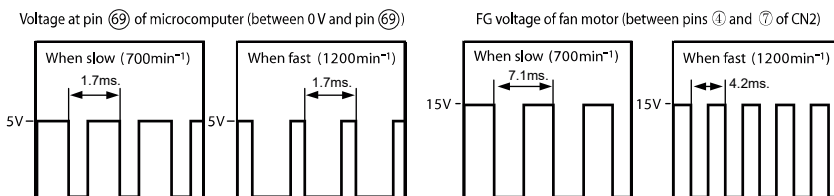

Fig. 3-2

- The indoor fan motor receives VDC (motor drive power supply), VCC (power supply for the control circuit inside the motor), and VS (speed command voltage) from CN2. The indoor fan motor returns an FG signal of a frequency that matches the rotation speed.
- VCC stabilizes the primary 18.5V power supply into 15V by using Q201 and supplies it.
- While on standby for a remote control signal, the Q201 shuts down the VCC and reduces the standby power.
- The VS receives a command voltage from the microcomputer. The VS terminal undergoes an analog voltage that matches the Lo level time ratio of the pulse signal from pin ⑥ of the microcomputer. (See Fig. 3-2.)
- The FG terminal undergoes a signal of 12 pulses per revolution of the motor shaft. By counting the pulse rate, the microcomputer recognizes the motor speed, thereby performing feedback control.

#### Caution

The indoor fan motor and drive circuit are connected to the primary power supply. They therefore have voltage to ground. Guard against electric shocks.

#### Caution

While the product is energized, do not under any circumstances detach or reattach a connector. Any such practice would cause a high voltage to run, resulting in the indoor fan motor and board circuit being destroyed. (Check the discharge of the C003 before detaching or reattaching the connectors.)

#### 4. Buzzer Circuit

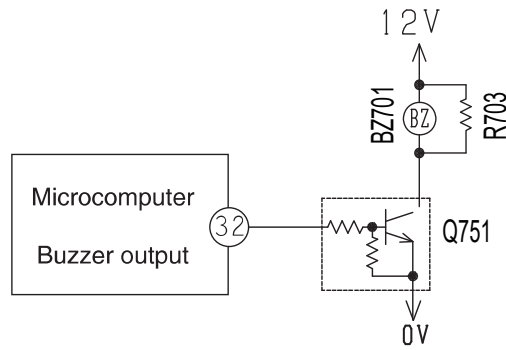

Fig.4-1 Buzzer Circuit

- When the buzzer sounds, an approx. 3.9kHz square signal is output from buzzer output pin (32) of the micro computer. After the amplitude of this signal has been set to 12Vp-p by a transistor, it is applied to the buzzer. The piezoelectric element in the buzzer oscillates to generate the buzzer's sound.

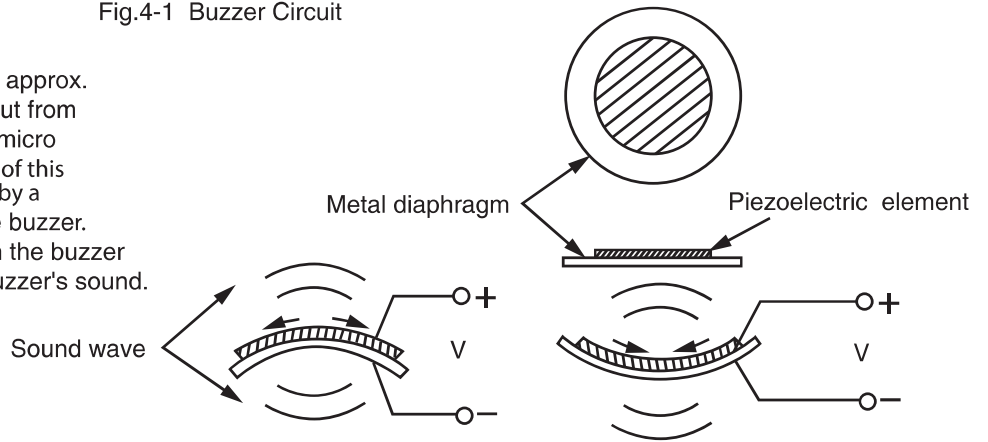

Fig.4-2 Buzzer Operation

#### 5. Remote control reception circuit

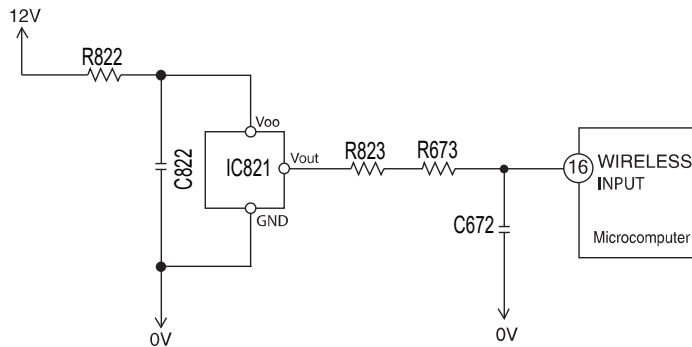

Fig.5-1

[Typical communication waveform]

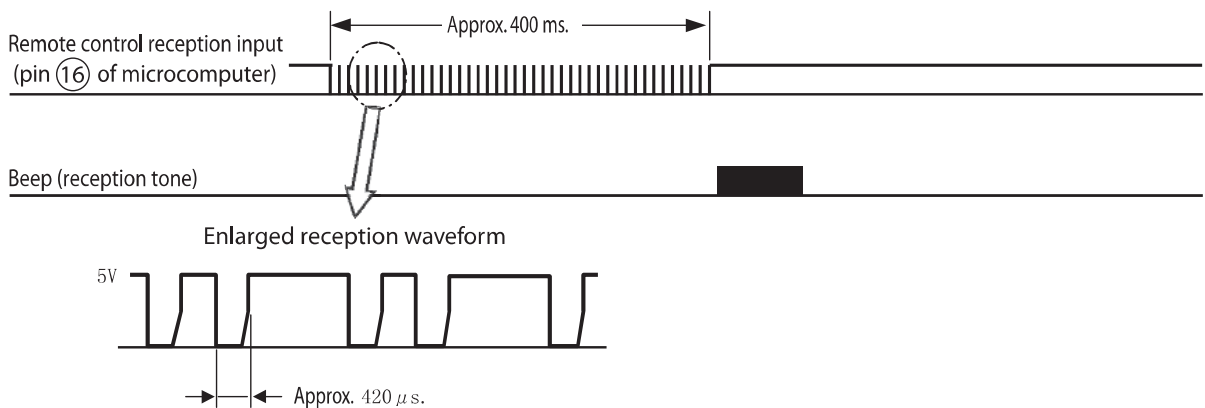
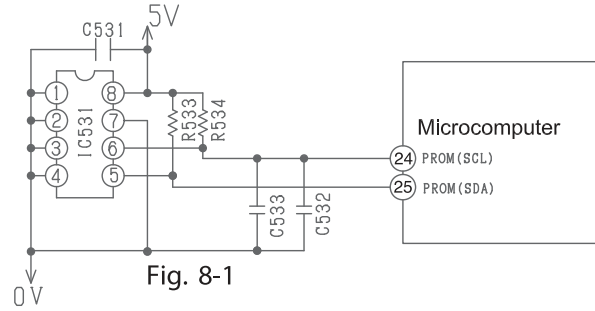

Fig. 5-2

- An infrared signal from the remote control unit is converted to an electrical signal by the remote control light-receiving unit and is received by the microcomputer. Data is transmitted as digital data 0 and 1 by changing the interval of the basic pulses at about 420 μs.

## 6. Initial Setting Circuit (IC531)

- When power is supplied, the microcomputer reads the data in IC531 (E<sup>2</sup>PROM) and sets the preheating activation value and the rating and maximum speed of the compressor, etc. to their initial values.
- Data of self-diagnosis mode is stored in IC531; data will not be erased even when power is turned off.



## 7. Temporary Switch Circuit

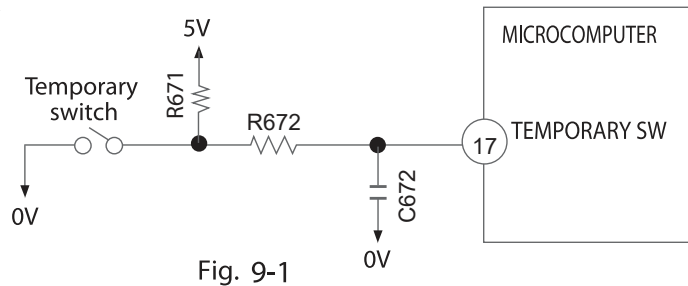

- The temporary switch is used to operate the air conditioner temporarily when the wireless remote control is lost or faulty.
- The air conditioner operates in the automatic mode by pressing the temporary switch. If the power switch is set to OFF then ON it also operates in the automatic mode when the temporary switch is pressed.

## 8. Room Temperature Thermistor Circuit

A room temperature thermistor circuit is shown in Fig. 8-1.

According to room temperature, the voltage of point (A) becomes as it is shown in Fig.8-2.

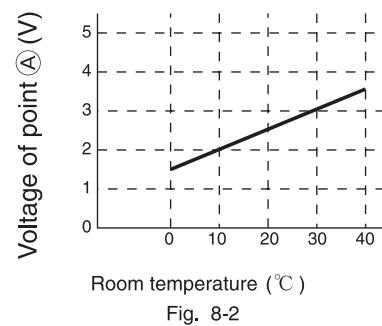
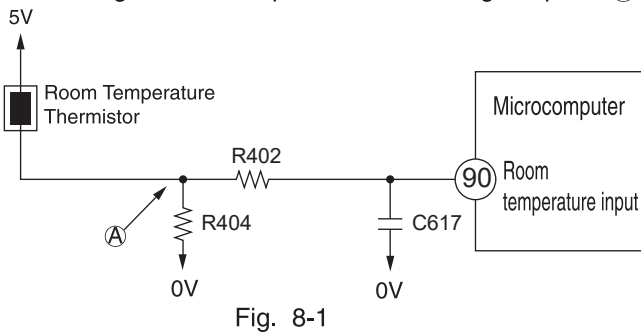



## 9. Heat Exchanger Thermistor Circuit

Heat exchanger temperature is noticed inside the room

- (1) Preheating
- (2) Low-temperature defrosts at cooling and dehumidification operation time.
- (3) Not working of reversing valve or detection of opening of heat exchanger thermistor is controlled.
- (4) The microcomputer will estimated the pressure of the compressor due to the intermediate temperature of the IDU heat exchanger.

When reach the set pressure value of the microcomputer, the compressor speed will be adjusted to protect the compressor pressure.

According to heat exchanger temperature, the voltage of point A becomes as it is shown in Fig. 9-2.

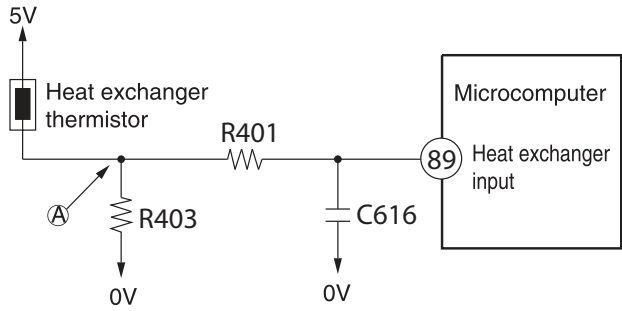

Fig. 9-1

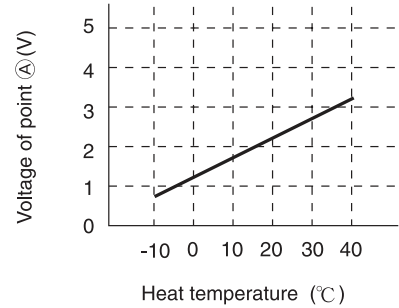
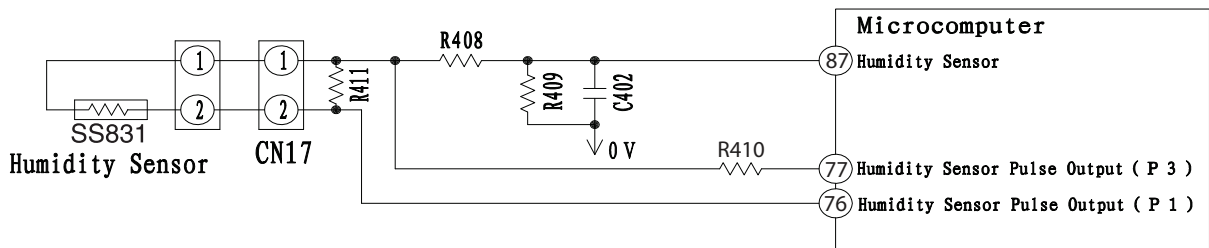

Fig. 9-2

## 10. Humidity sensor circuit



The resistance value of the humidity sensor is adjusted according to the change of ambient humidity.

With the change of resistance value, the voltage also changes, and the microcomputer will read the voltage signal.

# 11. Indoor/outdoor communication circuits

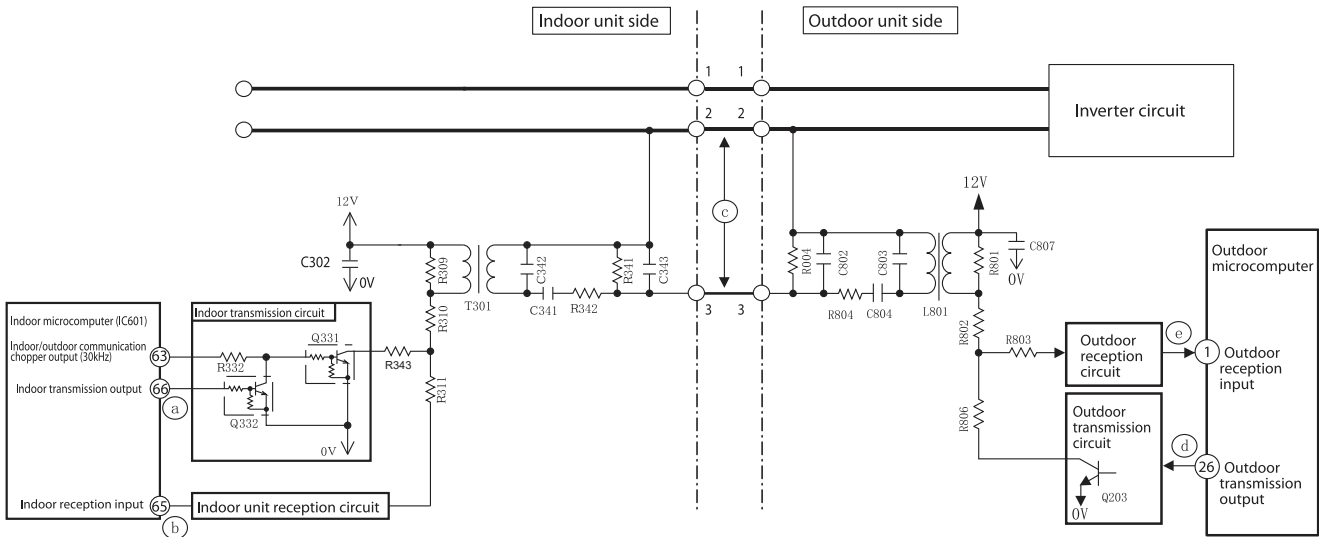

Fig. 11 -1

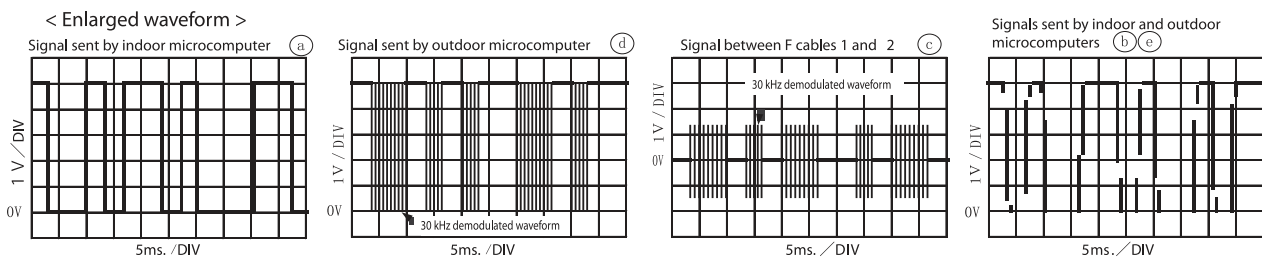
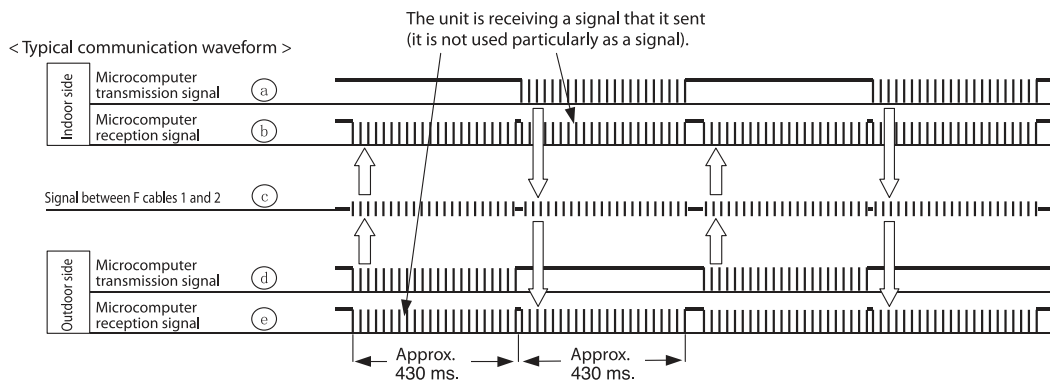

Fig. 11 -2

- Indoor and outdoor communications are conducted by using lines 2 and 3 of F cable. Line 2 of F cable is shared with a transmission channel that powers the outdoor unit.
- Data communicated between the indoor and outdoor units are outputted from the microcomputer as serial signals and are transmitted as demodulated by a 30 kHz carrier wave. (Both the indoor and outdoor microcomputers directly output a signal demodulated at 30 kHz.)

### Check

If a cable poorly inserted in the indoor terminal board or some other failure overheats the terminal board and the temperature fuse of the terminal board blows out, the power to the indoor communication circuit will be shut down to stop the communications function.

### Check

If communication fails between the indoor and outdoor units for some reason, the product will give a self-diagnosis display either by "the timer lamp blinking 3 times" or "the timer lamp blinking 12 times" depending on the cause.

# SERVICE CALL Q & A

MODEL RAK-DJ24PHAA

## Cooling operation

**Q1** The compressor sometimes stops during cooling.



**A1** Check if the heat exchanger of the indoor unit is covered with frost. Wait for 3 to 4 minutes until the frost disappears.

Cooling when the room temperature is low may cause the heat exchanger of the indoor unit to gather frost.

## Dehumidification

**Q1** The indoor unit produces a noise that goes "shaaahhh" during dehumidification.



**A1** That is a noise produced by refrigerant flowing through the pipe.

**Q2** Cold air comes out during a dehumidifying operation.



**A2** To improve the dehumidification efficiency performs quiet fan operation. Therefore the air is cold and it is not a malfunction.

**Q3** The operation does not stop even by setting the temperature higher than room temperature on the remote controller.



**A3** It sets to perform dehumidifying operation by setting the temperature slightly lower than remote controller setting.

## Heating operation

**Q1** The product sometimes fails to produce a wind during heating.



**A1** Defrosting is in progress. Wait 5 to 10 minutes until the frost on the outdoor unit disappears.

**Q2** The product begins with a slight fan speed during heating even though set to "Hi fan" or "Med fan" or "Low fan" or "silent fan".



**A2** At the first of the heating, the product will run for 30 seconds with a slight fan speed. When set to strong fan speed, the product will begin with a slight fan speed operation, producing a weak fan speed for 30 seconds, and then switch to strong fan speed.

**Q3** The product stops during heating even though it is set to "30°C".



**A3** When heating is conducted despite the high outdoor temperature, the product may stop to protect its equipment.

## Auto-fresh defrost

**Q1** During heating, I turned off the product by using the START/STOP button. But the "operation lamp" is blinking and the outdoor unit is running.



**A1** The "auto-fresh defrost" should be working. When stopped, the product will check its outdoor unit for frost and, if there is any frost, conduct defrosting and then stop operating.

## Automatic operation

**Q1** During an automatic run, switching the fan speed selector will not change the fan speed.



**A1** The product will switch automatically to automatic fan speed. You cannot select strong or weak fan speed by remote control but you can select fan speed and quiet.

**Q2** How is the automatic operation mode determined?



**A2** According to the room temperature, heating or cooling operation is automatically selected. Refer to the basic operation section.

## Common, etc.

**Q1** In "automatic fan speed" mode, the indoor fan changes from strong fan speed to weak fan speed to slight fan speed.



**A1** This does not abnormal. It is because the cold fan speed prevention is working.

In fan speed "automatic" mode, the product will sense the heat exchange temperature and, when the temperature goes down, the product will automatically switch to strong wind to weak fan speed to slight fan speed.

**Q2** At operation startup, the outdoor unit becomes noisy.



**A2** At operation startup, the product will set the rotation speed of the compressor to full power and increase its heating and cooling capacity, resulting in a slightly higher noise level. This is not a sign of a breakdown.

**Q3** The outdoor unit sometimes changes in its noise.



**A3** The difference between the thermometer temperature setting and room temperature will change the rotation speed of the compressor. This is not a sign of a breakdown.

**Q4** There is a difference between the temperature setting and room temperature in room temperature control.



**A4** The room structure, air stream, or other factor may cause a gap between the room temperature setting and actual room temperature. If there is any difference between the setting and the room temperature, adjust the temperature setting to match the living space to a comfortable temperature.

**Q5** The product will not produce wind right after startup.



**A5** After turning ON the power switch or breaker, setting the product to heating or dehumidification will activate a preliminary operation for 1 minute. At that time, heating will cause the operation lamp to blink. This is not a sign of a breakdown.

**Q6** I performed internal cleaning, but didn't succeed in controlling the mold in the room.



**A6** Internal cleaning will clean the inside of the indoor unit of the air-conditioner, thereby controlling mold generation. This will not control the mold in the room.

## Wireless remote control

**Q1** I tried to change the setting with the "room temperature" button of the remote control unit in vain.



**A1** You cannot make this setting when the product is in "air purification" mode. Moreover, you cannot set the product to a desired setting when quick laundry or dew control is being performed with the "auto" or "quick dehumidification" button.

## STRUCTURE OF AN INDOOR UNIT ELECTRIC PARTS

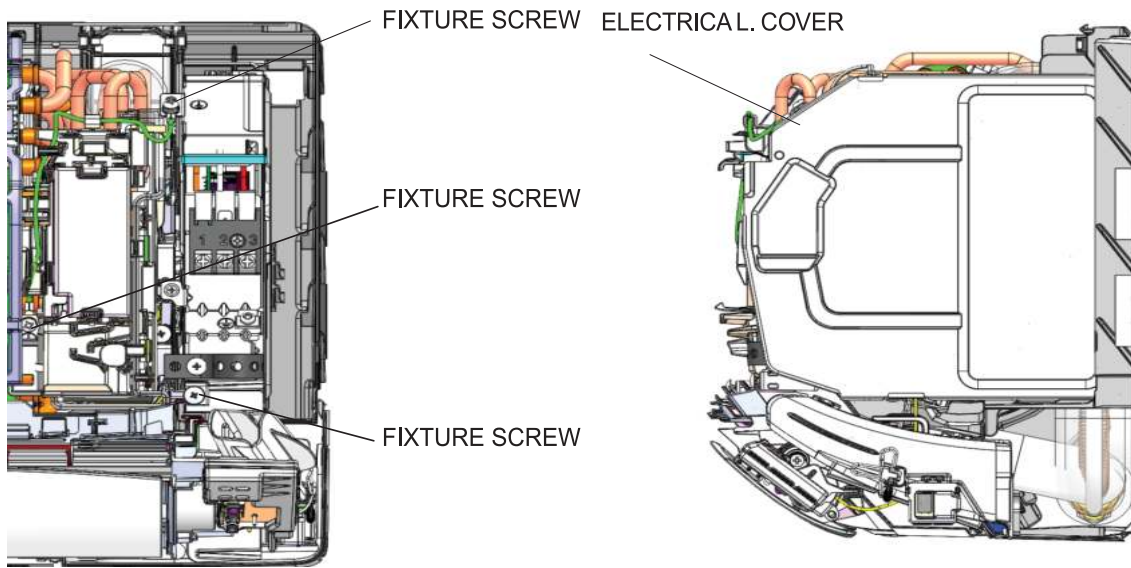

### Removing electrical parts

1. Remove the electrical parts cover.
2. Remove the connectors from the CN2, CN4, CN7A, CN12, CN16, CN17.

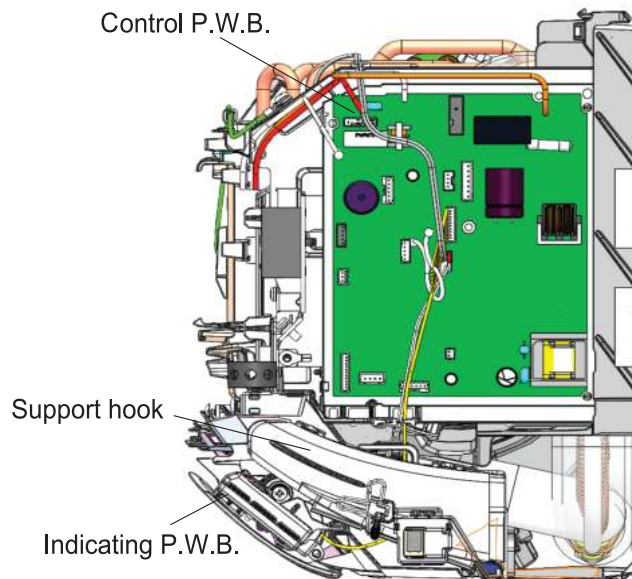

### Removing control P.W.B.

1. Remove all the connectors from the control P.W.B.
2. Remove the P.W.B. from the P.W.B. support.

### Removing the indicating P.W.B.

1. Remove the connector from the CN16 on the control P.W.B.
2. Remove the upper hook from the indicating P.W.B. lock resin, pull the P.W.B. forward a little and remove it.

## Other instructions

### (1) Detaching and reattaching the receptacles for tab terminal

All the receptacles for connecting tab terminals are with a locking mechanism. Forcibly pulling any such receptacle without unlocking it will destroy it. Be on guard.

When reconnecting it, insert it securely all the way home.

#### · Receptacle types and how to unlock them

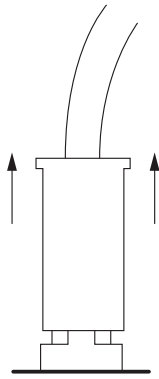

Vertical (with a resin case)

Hold the resin case and pull it out.

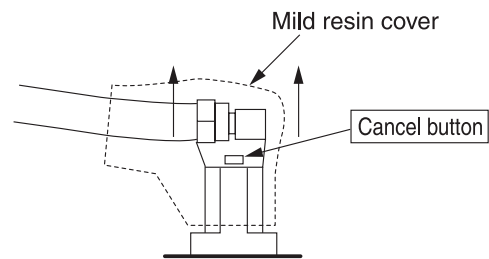

Horizontal (with a mild resin cover)

Hold the cancel button down on the mild resin cover while pulling it out.

### (2) Detaching and reattaching the board connector

The product comes equipped with many board connectors provided with lock mechanism. Forcibly pulling any such part without unlocking it will destroy it. Be on guard. When reconnecting it, insert it securely all the way home.

Pinch the locking mechanism with your fingers and pull it out unlocked.

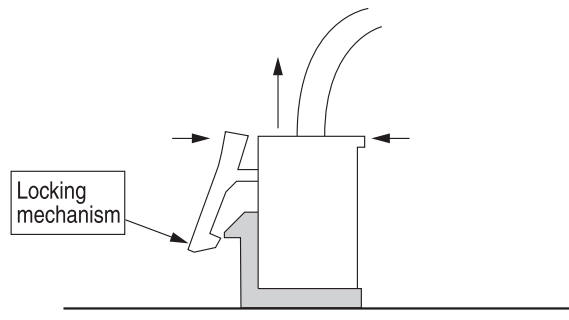

### (3) Do not detach or reattach the connectors while energized

Do not under any circumstances detach or reattach the connectors while energized. That would destroy the board components and fan motor. For both the indoor and outdoor boards, ensure that the smoothing capacitor has discharged its electricity fully before you do your work.

## Troubleshooting support

| No | Function  | Description  |
|----|---|--|
| 1  | <p>Self-diagnosis display<br/>[Display on the indoor unit side]</p> <p>[Buzzer on the indoor unit side]</p> <p>[Display on the outdoor unit side]</p> | <ul style="list-style-type: none"> <li>· The failure mode detected on the indoor unit side is displayed by blinking the "timer lamp". And a failure detected on the outdoor unit side will be indicated by the "time lamp" blinking 4 times.</li> <li>· If the outdoor unit side detects a failure, the product will first conduct several operation retrials.<br/>There are some failure modes with no lamp display while retrials are continued.<br/>[Failure mode where retrials are continued and the indoor unit lamp does not end up giving a display]<br/>OH thermistor heat-up<br/>Overload lower limit cut<br/>Low-frequency things</li> <li>· The failure codes both indoor unit and outdoor unit can be alerted by buzzer.</li> <li>· The failure mode detected on the outdoor unit side is displayed by blinking the "LD301". Detecting a failure will stop the outdoor unit and keep blinking the LD301 until it is restarted.<br/>(The communication error will persist until the communication is reestablished.)</li> </ul>  |
| 2  | Self-diagnosis memory   | <ul style="list-style-type: none"> <li>· The failure modes detected on the indoor and outdoor unit sides are stored in the nonvolatile memory of the indoor unit and can be read later on.<br/>(The memory will remain even after power-off.)</li> <li>· The failure modes detected on the outdoor unit side are written in memory every time any such mode occurs. The failure mode can therefore be detected on the indoor unit side without waiting for the retry frequency to reach the display of the indoor unit lamp. Moreover, the normal self-diagnosis display function which rarely occurs will store and display failure modes that do not end up displaying the indoor unit lamp.<br/>(Any such mode may be unable to be stored if indoor or outdoor communications is in a failure.)</li> <li>· The product stores 5 last-stored failure modes.</li> <li>· There is a function for deleting memory. Once you clear the memory and run the product for several days, you can read the failure modes and check them, thereby detecting the less frequent failure phenomena.</li> <li>· Failure modes can be checked by both the blinking of the lamp of the indoor unit and the sound of the buzzer</li> </ul> |

※The "self-diagnosis function of the communication circuit" available in our conventional models is now incorporated as part of the normal self-diagnosis function. In the case of a failure in the communication circuit, you do not have to conduct a special operation and the operations can be automatically divided into 3 blinking operations and 12 blinking operations of the timer lamp. However, a strong external noise may have resulted in 12 times of blinking.

## TROUBLESHOOTING WHEN TIMER LAMP BLINKS.

Perform troubleshooting according to the number of times the indoor timer lamp and outdoor blink.

### 1. How to count the lamp blinking frequency

- The product will repeat blinking with 2-second intermissions.
- The blinking speed is as follows: on for 0.35 seconds and off for 0.35 seconds.



- If you wish to try another operation while the lamp is blinking, operate the OFF/ON button on the remote control unit. The first push will reset the indoor microcomputer, while the second will activate the product (except for the mode in ※1).

## SELF-DIAGNOSIS LIGHTING MODE

Refer to the table below if the timer indicator (orange) is blinking.

| No.   | Blinking of Timer lamp | Reason for indication   | Possible cause   |
|-------|------------------------|---|--|
| 1     | once                   | <u>Refrigerant cycle defective</u>  | Refrigerant cycle defective  |
| 2     | 2 times                | <u>Outdoor unit forced operation</u><br>When the outdoor unit is in forced operation or balancing operation after forced operation  | Electrical parts in the outdoor unit   |
| 3     | 3 times                | <u>Indoor interface defective</u>   | Indoor interface circuit   |
| 4     | 4 times                | <u>Outdoor electrical assembly defective.</u>   | Please check at the outdoor electrical led lamp blinking (LD301) and refer to self diagnosis lighting mode for outdoor unit. |
| 5     | 9 times                | <u>Room thermistor or heat exchanger thermistor or humidity sensor is faulty.</u><br>When room thermistor or heat exchanger thermistor or humidity sensor is opened circuit or short circuit. | (1) Room thermistor<br>(2) Heat exchanger thermistor<br>(3) Humidity sensor  |
| 6     | 10 times               | <u>Over-current detection at the DC fan motor</u><br>when over-current is detected at the DC fan motor of the indoor unit.  | (1) Indoor fan locked<br>(2) Indoor fan motor<br>(3) Indoor control P.W.B.   |
| 7     | 12 times               | <u>Outdoor interface defective</u><br>When the interface signal from the outdoor unit is interrupted.   | Outdoor interface circuit  |
| ※1 8  | 13 times               | <u>IC531 data reading error</u><br>When data read from IC531 is incorrect.  | IC531 abnormal   |
| 9     | 21 times               | <u>Outdoor communication error</u><br>Communication failure due to other home appliances  | (1) Connecting cable check<br>(2) Removal of noise cause<br>(3) Connection cable is reverse                                  |
| ※2 10 | 25 times               | CN7A & CN7B connected with both RAC, wifi or H-link   | Please don't connect same external device CN7A & CN7B  |

( -- Lights for 0.35 sec. at interval of 0.35 sec..) )

※2 THE LAMP WILL BLINK ONLY WHEN 25 TIMES FAILURE IS CALLED OUT BY HHRC.

| All indicator lights are blinking.<br>※ Buzzer will be sounded at the same time as the installation first blinks. |                |                                     |  |
|---|----------------|-------------------------------------|--|
| Flashing lamp   | Blinking times | Checkpoint                          | Treatment and replacement parts  |
| All lamps   | 1              | Abnormal power supply               | If 100V is applied to the 200V model, it is not a failure. Please repair the power supply.       |
|   | 2              | Connecting cable connection failure | Insufficient insertion of terminal block inside and outside. Confirmation of reverse connection. |
|   | 3              | Forget to open the service valve    | Check if the service valve is open.  |

REFER TO THE BELOW TABLE IF THE INDOOR UNIT DOSE NOT WORK AT ALL.

|   |  |
|---|--|
| Fix CN2 connector   | Action/replacement parts,etc.                                    |
| FU1 (3.15A) fuse blown  | Replace the part which caused blowing/disconnection of FU1 fuse. |
| Come off or disconnection of the connector for indicating P.W.B | Fix CN16 connector   |
| Failure of control P.W.B  | Refer to the service guide for how to determine the failed part  |

### <Cautions>

- If the interface circuit is faulty when power is supplied, the self-diagnosis display will not be displayed.
- If the indoor unit does not operate at all, check to see if the connecting cable is connected or disconnected.



## SELF-DIAGNOSIS MEMORY FUNCTION

Failure modes are stored in the nonvolatile memory of indoor unit and shall be redisplayed by remote controller.



This function is useful in checking the failure modes either during switching OFF the power or restarting the device without checking the number of indication lamp blinking . Remote controller can redisplay up to last 5 failure modes from the memory. However, failure modes which are rarely to occur are also stored in the memory which caused the numbers of failure more than 5. Thus, for some failure modes which are unable to retrieve because of remote controller limit to redisplay only 5 failure modes, it can be found by clearing up the memory first then recheck the memory content again during the visit at the customer place.



## ERROR CODE INFORMATION

### <HOW TO DISPLAY ERROR CODE >

1. Press three key ( [On Timer] + [Fan Speed] + [Reset] ) button on the remote control for 5 seconds to avoid access by User.

2. Press “” (Temperature) button of the remote control and select the “7J” option.

3. Press “” (Fan Speed) button of the remote control, then Press “” (Temperature) button select the “t0” option.

4. Press “” (Fan Speed) button of the remote control, then Press “” (Temperature) button select the “01” option.



5. Press “” (On/Off) button of the remote control, the fault information will be seen.



| Function Name                    | Value   | Layer1   | Layer2   | Layer3 |
|----------------------------------|---|----------|----------|--------|
|                                  |   | Category | Function | Value  |
| Display self-diagnosis memory(※) | Display History 1<br>( Latest(newest) of last Five) | 7J       | t0       | 01     |
|                                  | Display History 2                                   |          |          | 02     |
|                                  | Display History 3                                   |          |          | 03     |
|                                  | Display History 4                                   |          |          | 04     |
|                                  | Display History 5                                   |          |          | 05     |

### <HOW TO REMOVE ERROR CODE>

1. Press three key ( [On Timer] + [Fan Speed] + [Reset] ) button on the remote control for 5 seconds to avoid access by User.

2. Press “” (Temperature) button of the remote control and select the “7J” option.

3. Press “” (Fan Speed) button of the remote control, then Press “” (Temperature) button select the “t2” option.

4. Press “” (Fan Speed) button of the remote control, then Press “” (Temperature) button select the “01” option.

5. Press “” (On/Off) button of the remote control, and the error code will be removed.

|        | TIMER LAMP BLINKING | LD301<br>BLINKING | CODE      | MEANING                                   |
|--------|---------------------|-------------------|-----------|---|
| INDOOR | -                   | -                 | 000<br>00 | Normal                                    |
|        | 1 time              |                   | 001<br>00 | Refrigerant cycle fault                   |
|        | 2 times             | -                 | -         | Outdoor unit is under forced operation    |
|        | 3 times             | 9 times           | 003<br>00 | Communication error (indoor)              |
|        | 9 times             | -                 | 009<br>00 | Indoor thermistor defective               |
|        | 10 times            | -                 | 010<br>00 | Abnormal rotating numbers of DC fan motor |
|        | 12 times            | 9 times           | 012<br>00 | Communication error (outdoor)             |
|        | 13 times            | -                 | 013<br>00 | EEPROM data reading error                 |
|        | 21 times            | -                 | 021<br>00 | Interface defective (other machine cause) |

< Cautions >

This function is effective only once immediately after the power is turned on. It will not work if you have performed another remote control operation beforehand. Note also that it may not function in response to a procedure other than the above. (If it does not work, turn off the power, turn it back on and repeat the procedure.)

If the memory stores nothing, performing a redisplay operation will not blink the lamp.

For a normal operation, turn off the power and turn it back on. After the above operation, the product will not receive a remote control signal normally.

After clearing the troubleshooting data, turn off the power. (If you do not turn off the power, the product will become unresponsive to remote control signals.)

## Forced cooling operation (Only single connection)

The cooling operation can be forcibly performed for collecting refrigerant and inspecting failures. Do not perform the forced cooling operation continuously for long hours, because the compressor continues to be in operational status, regardless of room temperature.

<How to start the operation>

- The operation of the unit should be stopped.
- Press and hold the "Temporary operation SW" shown in the right figure for 5 sec.

<How to stop the operation>

- Press and hold the "Temporary operation SW" again.
- Or stop the operation using the remote controller.

※During the forced cooling operation, the "Timer indicator" blinks twice.

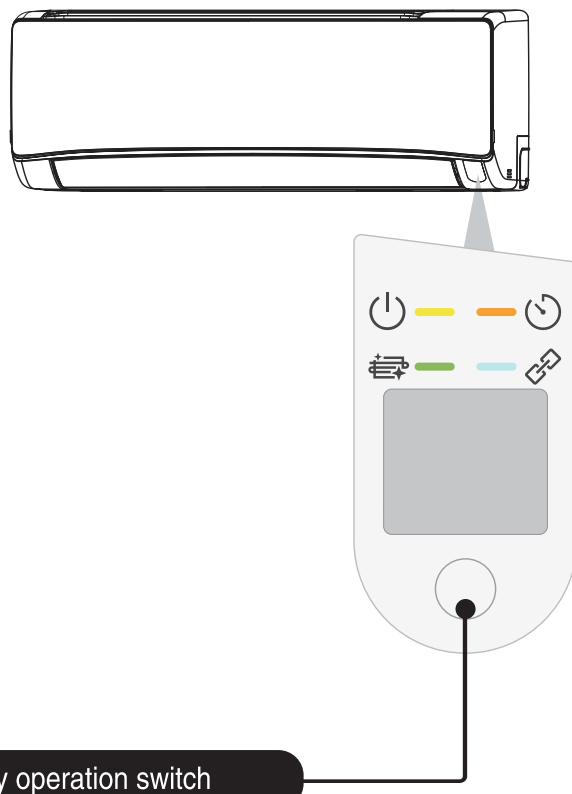

Temporary operation switch

When performing the forced cooling operation, turn the power off once. If you press and hold the switch for 5 sec or longer, the forced cooling operation starts. To stop the forced cooling operation, press the switch once again or stop the operation using the remote controller.

## How to set up from Service setting mode

The Service function, which was set by DIP-SW setting or double pressing of the HHRC in the current model. it will be done by HHRC in GRAC as shown as below.

[On timer] + [Fan speed] + [Reset]  
( Press three Key for 5 seconds to avoid access by User )

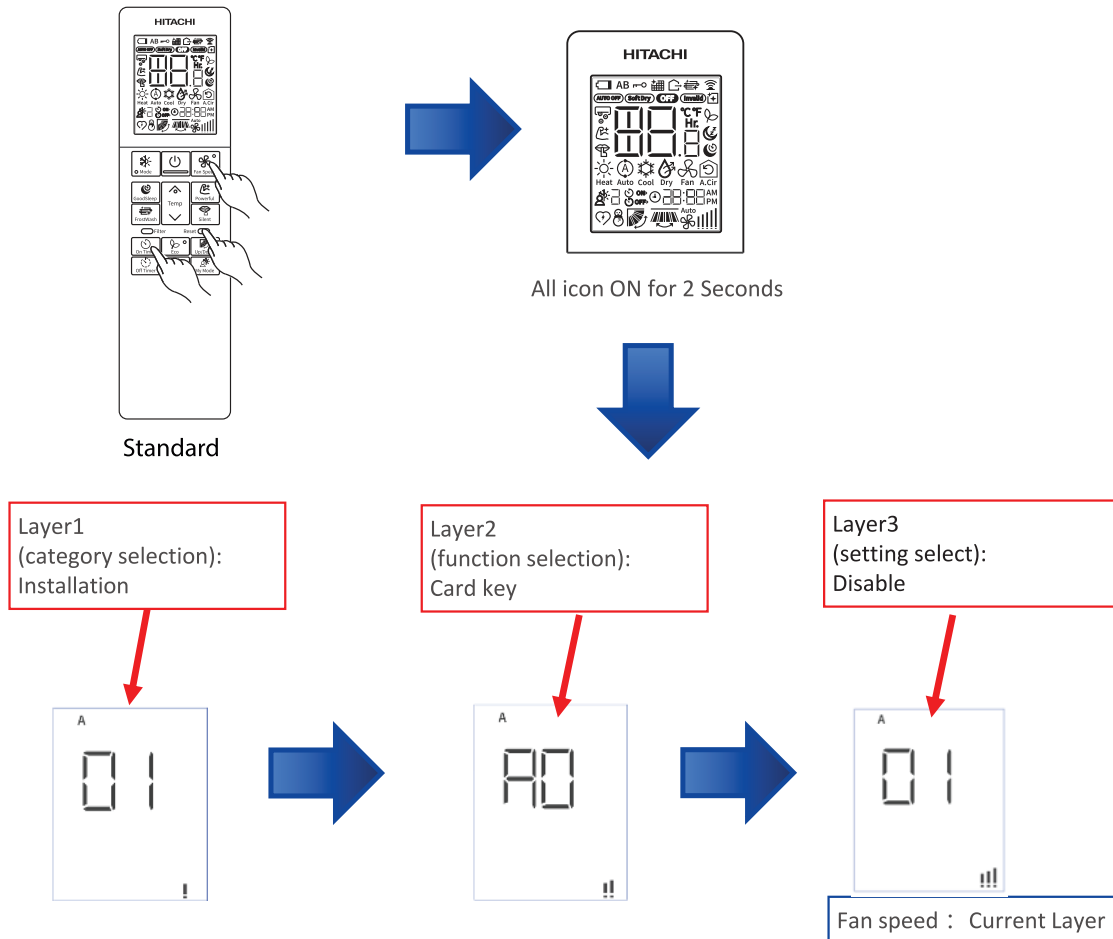

※ If you don't do anything for 30 seconds, you will be out of the service setting mode.

## How to operate the HHRC method

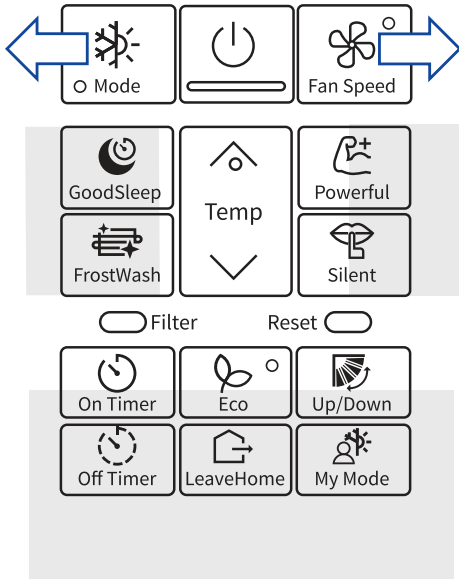

Temp $\Delta$  $\nabla$  : Selection (in the same layer)  
 Mode : move to previous layer  
 Fan Speed : Move to next layer  
 ON/OFF : Decision/Send (at layer 3)  
           : Current setting check(at layer 2)  
 Filter: category initialization(at layer 1)  
 Filter + ON/OFF: all category initialization(at layer 1)  
 ※ To exit from this setting mode, you need to either not operate the HHRC panel for 30 seconds or press and hold the UP/Down key for 5 seconds.

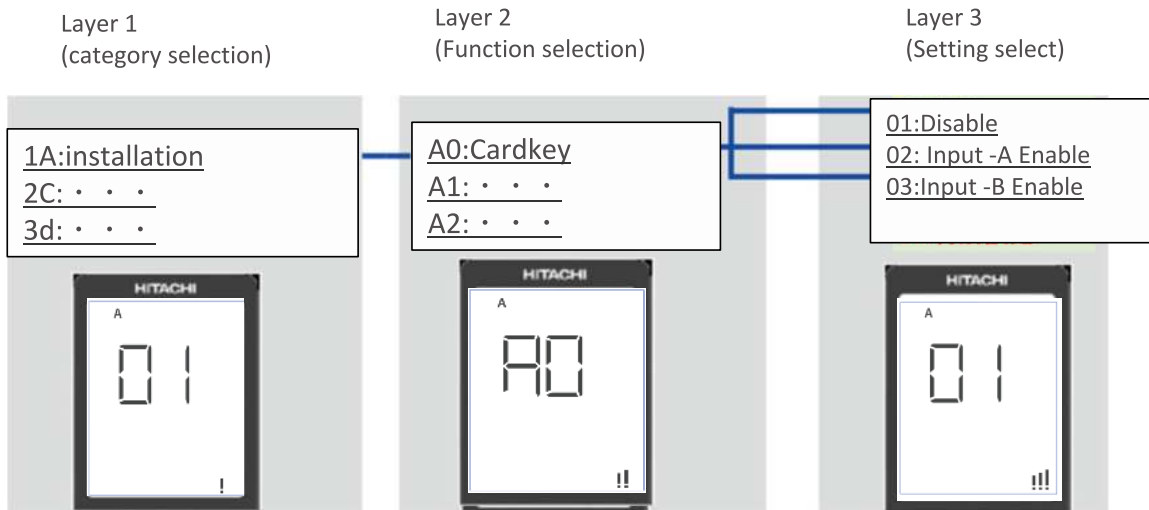

## Service setting item used for GRAC Entry

| Category        | Function Name   | Value   | HHRC LCD display |                       |        | L1<br>(Category)   |  |
|-----------------|---|---|------------------|-----------------------|--------|--|--|
|                 |   |   | Layer1           | Layer2                | Layer3 |  |  |
|                 |   |   | Category         | Function              | Value  |  |  |
| Installation    | Card Key  | Disable   | 1A               | A0                    | 01     | L1<br>(Category)<br>1A<br>Installation<br>2C<br>Clean<br>3d<br>cycle operation<br>adjustment<br>4E<br>Fan control  |  |
|                 |   | Card Key Input -A Enable                        |                  |                       | 02     |  |  |
|                 |   | Card Key Input -B Enable                        |                  |                       | 03     |  |  |
|                 |   | reserve   |                  |                       | 04-99  |  |  |
|                 | Mode Lock   | Normal Mode                                     | 1A               | A1                    | 01     | 5F<br>supporting service<br>6H<br>HHRC<br>7J<br>Diagnosis<br>8L<br>Future  |  |
|                 |   | Cooling Lock<br>(Cool, Dry, Fan mode available) |                  |                       | 02     |  |  |
|                 |   | Heating Lock<br>(Heat and Fan mode available)   |                  |                       | 03     |  |  |
|                 |   | reserve   |                  |                       | 04-99  |  |  |
|                 | Auto restart  | auto restart changeover disable                 | 1A               | A2                    | 01     |  |  |
|                 |   | auto restart by previous mode                   |                  |                       | 02     |  |  |
|                 |   | reserve   |                  |                       | 03-99  |  |  |
|                 |   |   |                  |                       |        |  |  |
| Cycle operation | Defrost selection Function  | average area setting                            | 3d               | E0                    | 01     | L1<br>(Category)<br>1A<br>Installation<br>2C<br>Clean<br>3d<br>cycle operation<br>adjustment<br>4E<br>Fan control<br>5F<br>supporting service<br>6H<br>HHRC<br>7J<br>Diagnosis<br>8L<br>Future |  |
|                 |   | cold area setting                               |                  |                       | 02     |  |  |
|                 |   | reserve   |                  |                       | 03-99  |  |  |
|                 | Shift value adjustment of<br>setting temperature<br>(Cool Mode,<br>Heat Mode) | (-5° C/-10° F)                                  | 3d               | E1(Cool)/E2(H<br>eat) | 01     |  |  |
|                 |   | (-4° C/-8° F)                                   |                  |                       | 02     |  |  |
|                 |   | (-3° C/-6° F)                                   |                  |                       | 03     |  |  |
|                 |   | (-2° C/-4° F)                                   |                  |                       | 04     |  |  |
|                 |   | (-1° C/-2° F)                                   |                  |                       | 05     |  |  |
|                 |   | (±0° C/±0° F)                                   |                  |                       | 06     |  |  |
|                 |   | (+1° C/2° F)                                    |                  |                       | 07     |  |  |
|                 |   | (+2° C/4° F)                                    |                  |                       | 08     |  |  |
|                 |   | (+3° C/6° F)                                    |                  |                       | 09     |  |  |
|                 |   | (+4° C/8° F)                                    |                  |                       | 10     |  |  |
|                 |   | (+5° C/10° F)                                   |                  |                       | 11     |  |  |
|                 | reserve   | 12-99   |                  |                       |        |  |  |
|                 | Cycle operation   | IDU fan control at cooling<br>thermo-off        | ultra low        | 3d                    | E3     | 01   | L1<br>(Category)<br>1A<br>Installation<br>2C<br>Clean<br>3d<br>cycle operation<br>adjustment<br>4E<br>Fan control<br>5F<br>supporting service<br>6H<br>HHRC<br>7J<br>Diagnosis<br>8L<br>Future |
|                 |   |   | set fan speed    |                       |        | 02   |  |
| reserve         |   |   | 03-99            |                       |        |  |  |
| HHRC            | Temperature Resolution<br>change - 0.5 --> 1                                  | 0.5° C  | 6H               | P0                    | 01     | L1<br>(Category)<br>1A<br>Installation<br>2C<br>Clean<br>3d<br>cycle operation<br>adjustment<br>4E<br>Fan control<br>5F<br>supporting service<br>6H<br>HHRC<br>7J<br>Diagnosis<br>8L<br>Future |  |
|                 |   | 1° C  |                  |                       | 02     |  |  |
|                 | Fan Speed key sequence  | Auto-Silent - Low-Med-Hi-Super Hi               |                  | P1                    | 01     |  |  |
|                 |   | Super Hi-Hi-Med-Lo-Silent -Auto                 |                  |                       | 02     |  |  |
|                 | Operation Mode : Auto   | Disable Selection on HHRC                       |                  | P2                    | 01     |  |  |
|                 |   | Enable Selection on HHRC                        |                  |                       | 02     |  |  |
|                 | Operation Mode : Cool   | Disable Selection on HHRC                       |                  | P3                    | 01     |  |  |
|                 |   | Enable Selection on HHRC                        |                  |                       | 02     |  |  |
|                 | Operation Mode : Dry  | Disable Selection on HHRC                       |                  | P4                    | 01     |  |  |
|                 |   | Enable Selection on HHRC                        |                  |                       | 02     |  |  |
|                 | Operation Mode : Fan  | Disable Selection on HHRC                       |                  | P5                    | 01     |  |  |
|                 |   | Enable Selection on HHRC                        |                  |                       | 02     |  |  |

## Service setting item used for GRAC Entry

| Category  | Function Name                         | Value   | HHRC LCD display |          |        | L1<br>(Category)                 |
|-----------|---------------------------------------|---|------------------|----------|--------|----------------------------------|
|           |                                       |   | Layer1           | Layer2   | Layer3 | 1A<br>Installation               |
|           |                                       |   | Category         | Function | Value  | 2C<br>Clean                      |
| HHRC      | Operation Mode : Heat                 | Disable Selection on HHRC                           | 6H               | P6       | 01     | 3d<br>cycle operation adjustment |
|           |                                       | Enable Selection on HHRC                            |                  |          | 02     | 4E<br>Fan control                |
|           | Auto Fan speed : Enable / Disable     | Disable Selection on HHRC                           |                  | P8       | 01     | 5F<br>supporting service         |
|           |                                       | Enable Selection on HHRC                            |                  |          | 02     | 6H<br>HHRC                       |
|           | Super hi Fan speed : Enable / Disable | Enable Selection on HHRC                            |                  | P9       | 01     | 7J<br>Diagnosis                  |
|           |                                       | Disable Selection on HHRC                           |                  |          | 02     | 8L<br>Future                     |
| HHRC      | Cooling Lower limit setting           | 60°F (16°C)   | 6H               | PC       | 01     | L1<br>(Category)                 |
|           |                                       | 62°F (17°C)   |                  |          | 02     | 1A<br>Installation               |
|           |                                       | 64°F (18°C)   |                  |          | 03     | 2C<br>Clean                      |
|           |                                       | 66°F (19°C)   |                  |          | 04     | 3d<br>cycle operation adjustment |
|           |                                       | 68°F (20°C)   |                  |          | 05     | 4E<br>Fan control                |
|           |                                       | 70°F (21°C)   |                  |          | 06     | 5F<br>supporting service         |
|           |                                       | 72°F (22°C)   |                  |          | 07     | 6H<br>HHRC                       |
|           |                                       | 74°F (23°C)   |                  |          | 08     | 7J<br>Diagnosis                  |
|           |                                       | 76°F (24°C)   |                  |          | 09     | 8L<br>Future                     |
|           |                                       | 77°F (25°C)   |                  |          | 10     |                                  |
|           |                                       | 78°F (26°C)   |                  |          | 11     |                                  |
|           |                                       | 80°F (27°C)   |                  |          | 12     |                                  |
|           |                                       | 82°F (28°C)   |                  |          | 13     |                                  |
|           |                                       | 84°F (29°C)   |                  |          | 14     |                                  |
|           |                                       | 86°F (30°C)   |                  |          | 15     |                                  |
|           |                                       | 88°F (31°C)   |                  |          | 16     |                                  |
|           |                                       | 90°F (32°C)   |                  |          | 17     |                                  |
| HHRC      | Heating Upper limit setting           | 90°F (32°C)   | 6H               | Pd       | 01     | L1<br>(Category)                 |
|           |                                       | 88°F (31°C)   |                  |          | 02     | 1A<br>Installation               |
|           |                                       | 86°F (30°C)   |                  |          | 03     | 2C<br>Clean                      |
|           |                                       | 84°F (29°C)   |                  |          | 04     | 3d<br>cycle operation adjustment |
|           |                                       | 82°F (28°C)   |                  |          | 05     | 4E<br>Fan control                |
|           |                                       | 80°F (27°C)   |                  |          | 06     | 5F<br>supporting service         |
|           |                                       | 78°F (26°C)   |                  |          | 07     | 6H<br>HHRC                       |
|           |                                       | 77°F (25°C)   |                  |          | 08     | 7J<br>Diagnosis                  |
|           |                                       | 76°F (24°C)   |                  |          | 09     | 8L<br>Future                     |
|           |                                       | 74°F (23°C)   |                  |          | 10     |                                  |
|           |                                       | 72°F (22°C)   |                  |          | 11     |                                  |
|           |                                       | 70°F (21°C)   |                  |          | 12     |                                  |
|           |                                       | 68°F (20°C)   |                  |          | 13     |                                  |
|           |                                       | 66°F (19°C)   |                  |          | 14     |                                  |
|           |                                       | 64°F (18°C)   |                  |          | 15     |                                  |
|           |                                       | 62°F (17°C)   |                  |          | 16     |                                  |
|           |                                       | 60°F (16°C)   |                  |          | 17     |                                  |
| Diagnosis | Display self-diagnosis memory(※)      | Display History 1<br>( Latest(newest) of last Five) | 7J               | t0       | 01     | L1<br>(Category)                 |
|           |                                       | Display History 2                                   |                  |          | 02     | 1A<br>Installation               |
|           |                                       | Display History 3                                   |                  |          | 03     | 2C<br>Clean                      |
|           |                                       | Display History 4                                   |                  |          | 04     | 3d<br>cycle operation adjustment |
|           |                                       | Display History 5                                   |                  |          | 05     | 4E<br>Fan control                |
|           | Display ODU self-check result         | request   |                  | t1       | 01     | 5F<br>supporting service         |
|           |                                       | reserve   |                  |          | 02-99  |                                  |
|           | Erase self-diagnosis memory(※)        | request   |                  | t2       | 01     | 6H<br>HHRC                       |
|           |                                       | reserve   |                  |          | 02-99  | 7J<br>Diagnosis                  |
|           | Humidity sensor failure diagnosis     | request   |                  | t3       | 01     | 8L<br>Future                     |
|           |                                       | reserve   |                  |          | 02-99  |                                  |

## Buzzer sounding for showing error contents

### 【Purpose】

Reduction of "mis-communication about error contents" at contacting the service call center. 【Function】

Add buzzer sounding for showing error contents during error, in addition to IDU LED action . 【How to use】

When IDU or ODU has failed, and the Timer lamp is blinking. Service engineer can know error contents from the buzzer through phone.

### 〔Up/Down〕

( Press this Key for 5 seconds)

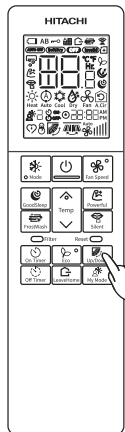

In case of IDU failure



LED action



Timer lamp is blinking

Buzzer action



In case of ODU failure



LED action



Operation lamp is blinking

Buzzer action



Sounding by same rhythm with LED

### 【note】

- for stopping buzzer, stop by On/Off button, or press Up/Down button for 5 seconds.

<IDU error example: timer LED will blink 3 times(interface defective(IDU) >

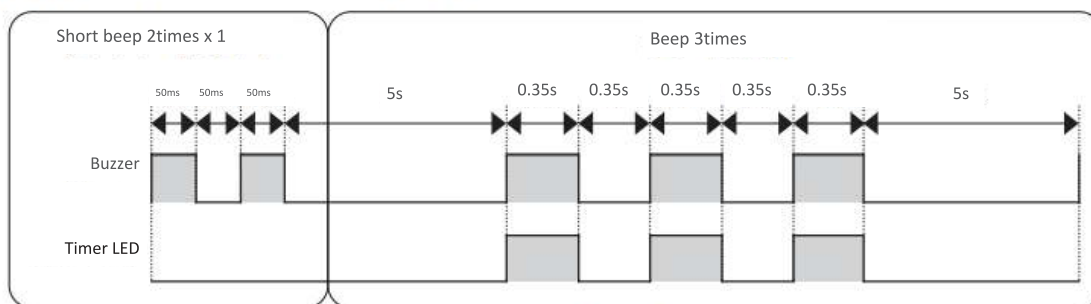

After "Short 2times x 1 beep", "3 times beep" will be repeated.

<ODU error example: operation LED will blink 2 times(peak current cut) >

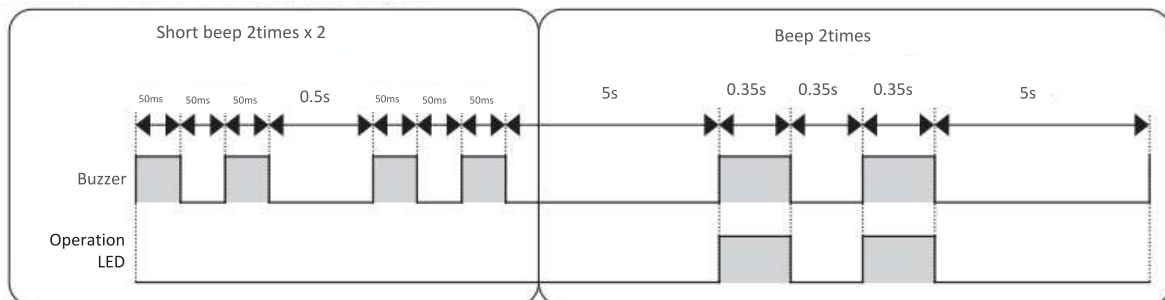

After "Short 2times x 2 beep", "2 times beep" will be repeated.



## OTHER SETTING

### ▪ ID SELECTION

1. Press “Up/Down swing button” and “set. Temp. up button” and “reset button”, and release “reset button”.
2. Select from A or B by pressing “set.temp. button”.
3. Press “On/Off button” toward IDU.

(EEPROM in HHRC will keep the A or B information.)

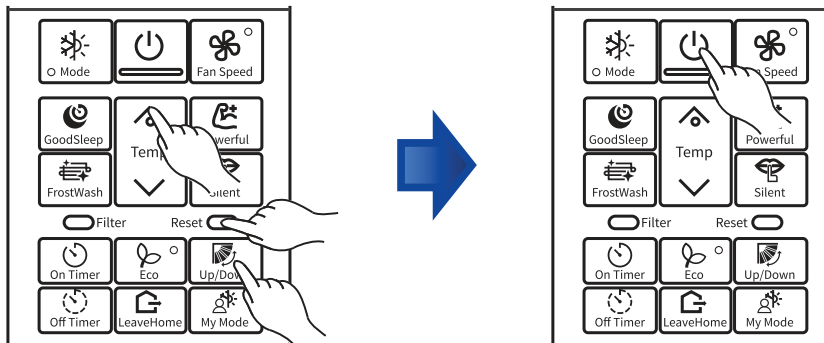

### ▪ DISPLAY MODE

1. Press “On Timer button” and “On/Off button” and “reset button”, and release “reset button”.
2. Fan speed icon(  ) on LCD will blink.
3. Press “On/Off button” toward IDU.

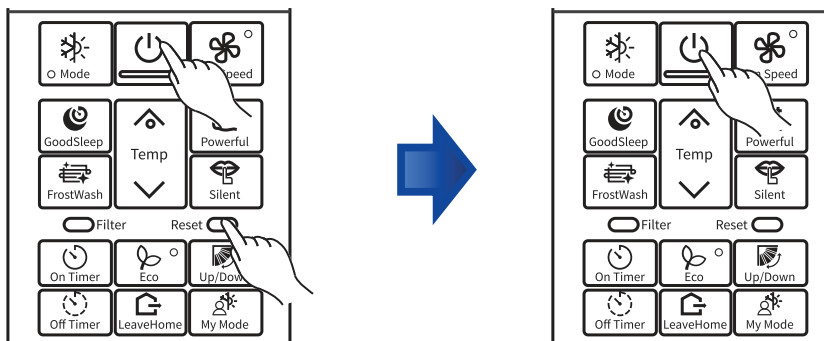

## Diagnosis and troubleshooting of indoor electric parts

### Initiating troubleshooting

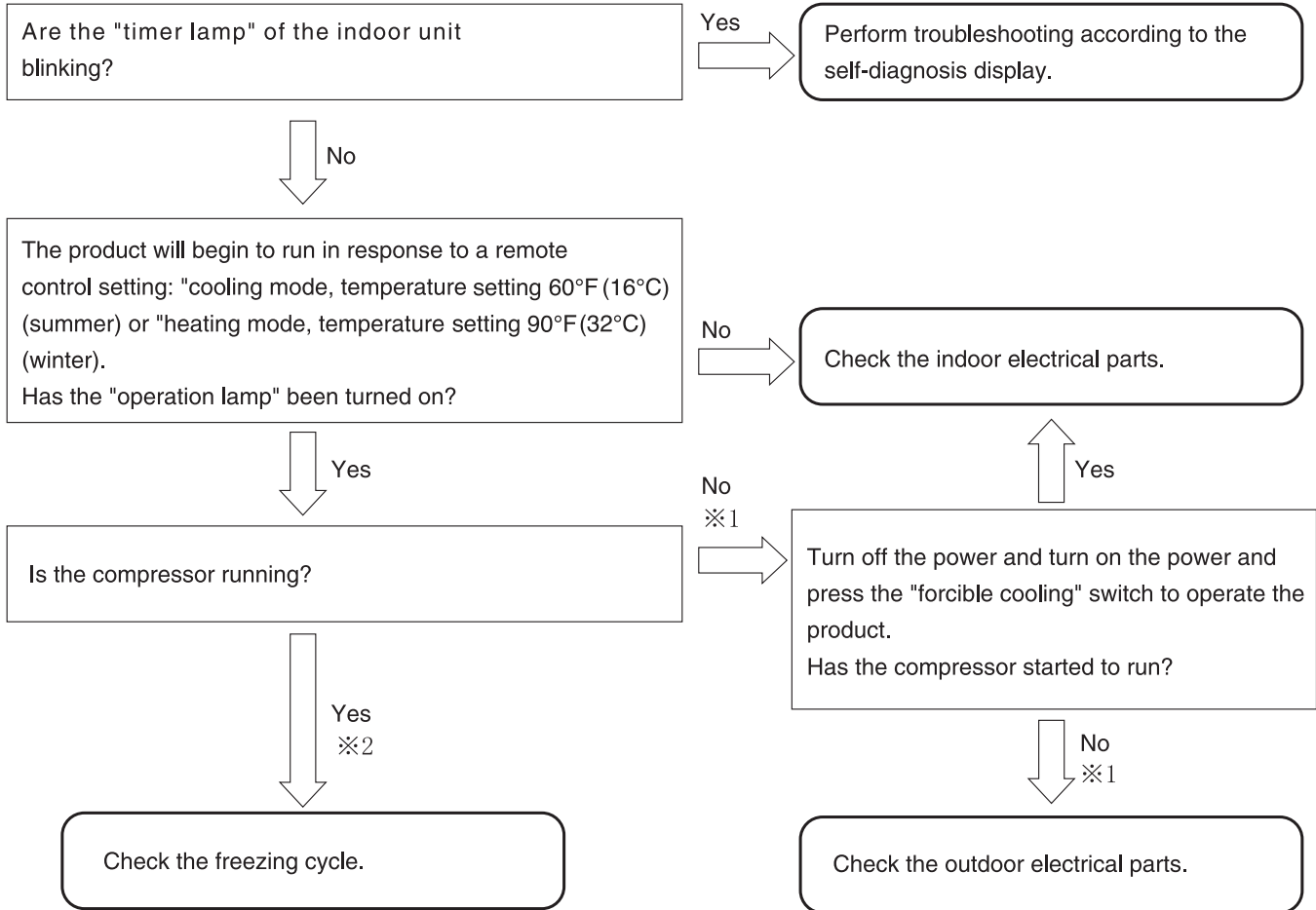

### < Troubleshooting by using the self-diagnosis memory function >

- By using the self-diagnosis memory function, you can check the failure mode (※1) occurring in the outdoor electrical parts on the indoor unit side.

- Steps
1. Clear the troubleshooting data.
  2. Run the product for several minutes under the conditions where the compressor runs.
  3. Redisplay and check the data written in the self-diagnosis memory.

- The self-diagnosis memory function can also be used to catch sporadic failure phenomena.

- Steps
1. Clear the troubleshooting data.
  2. Have the user use the product as usual until a failure phenomenon occurs.  
(The period depends on the incidence of the phenomenon.)
  3. At a later date, redisplay and check the data written in the self-diagnosis memory.

- For the outdoor self-diagnosis display (OH thermistor heat-up, overload lower limit cut) stemming from the freezing cycle or operating condition, the time lag is long from operation startup to the emergence of the phenomenon. Moreover, it is affected by the temperature, sunshine, operating hours, and other factors of the day, so that the phenomenon may not be able to be identified at the time of a repair service visit. In that case too, use the self-diagnosis memory function (※2).
- The outdoor self-diagnosis display "overload lower limit cut" and "OH thermistor heat-up" can be identified only when you are using the self-diagnosis lamp of the outdoor unit and the self-diagnosis memory function of the indoor unit. Note that this will not be automatically displayed on the indoor unit side.

## Checking the indoor unit electrical parts

### Introduction

First check the failure phenomenon and status, and then move on to elaborate diagnosis.

#### Initiating troubleshooting

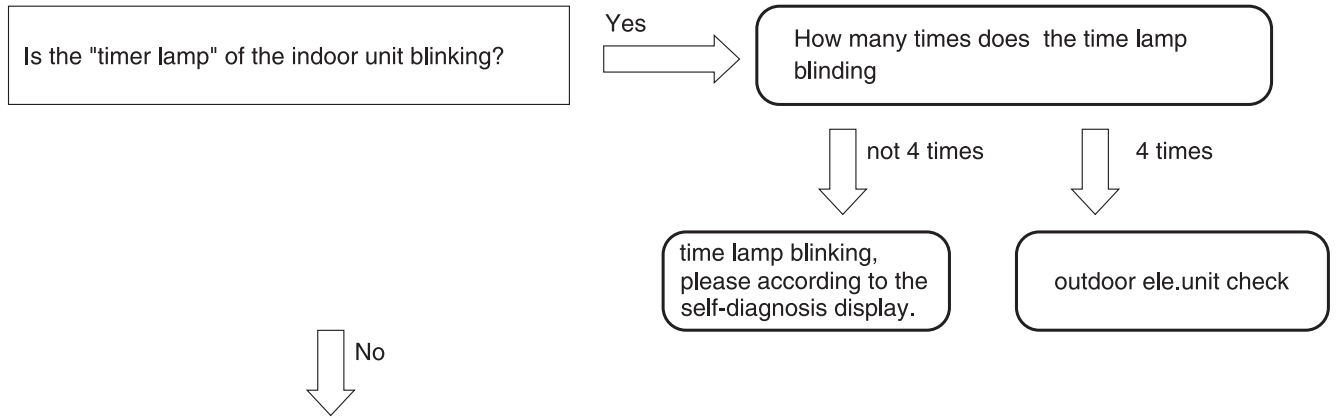

Turn off the power, wait at least 5 seconds, turn it back on, and observe the way the horizontal vanes move for about 30 seconds.

Check 1: Have the horizontal vanes moved? (Yes/No)

Set the remote control unit to cooling mode, temperature setting 16°C (summer), heating mode, temperature setting 32°C (winter) and operate the product.

Check 2: Has the product received the remote control signal and has the "operation lamp" gone on? (Yes/No)

If you responded "Yes" to Check 2:

Check 3: Is the compressor of the outdoor unit running? (Yes/No)

If you responded "No" to Check 2:

Check 4: Does the "emergency operation switch" work? (Yes/No)

#### Check results and next check items

| Check 1 | Check 2 | Check 3 | Check 4 | Next check item  |
|---------|---------|---------|---------|--|
| No      | No      | —       | No      | Go on to "The power will not become turned on".                    |
| Yes     | No      | —       | Yes     | Go on to "The product will not receive the remote control signal". |
| Yes     | Yes     | No      | —       | Go on to "The compressor will not run".                            |

# 1. Failure phenomenon: The power will not become turned on.

[ Situation ] Neither initialization, remote control, nor any other step works on the vane position at power-on.

- [ Estimated failure locations ]
- 3.15 A fuse blown out
  - Control power circuit
  - Connector loose, wire break

Estimated cause of fuse blowout

- Abnormally high voltage applied to the power supply
- Indoor fan motor out of order
- Power circuit out of order

- [ Cautions ]
- Before work, check the power supply voltage. An abnormal voltage may be being supplied in some rare occasions due to a defect in the indoor wiring (a wire break in the neutral wire of the single-phase 3-wire power supply).
  - If the 3.15 A fuse has blown out, eliminate the cause of the fuse blowout. Otherwise, there will occur another fuse blowout.
  - If the 3.15 A fuse has blown out due to an abnormally high voltage to the power supply, the varistor (VA001) will deteriorate and become destroyed as well.
  - On a repair service visit due to the failure phenomenon of "The power will not become turned on", take a "3.15 A fuse" and a "varistor" with you.

## [ Diagnosis flow ]

### Initiating troubleshooting

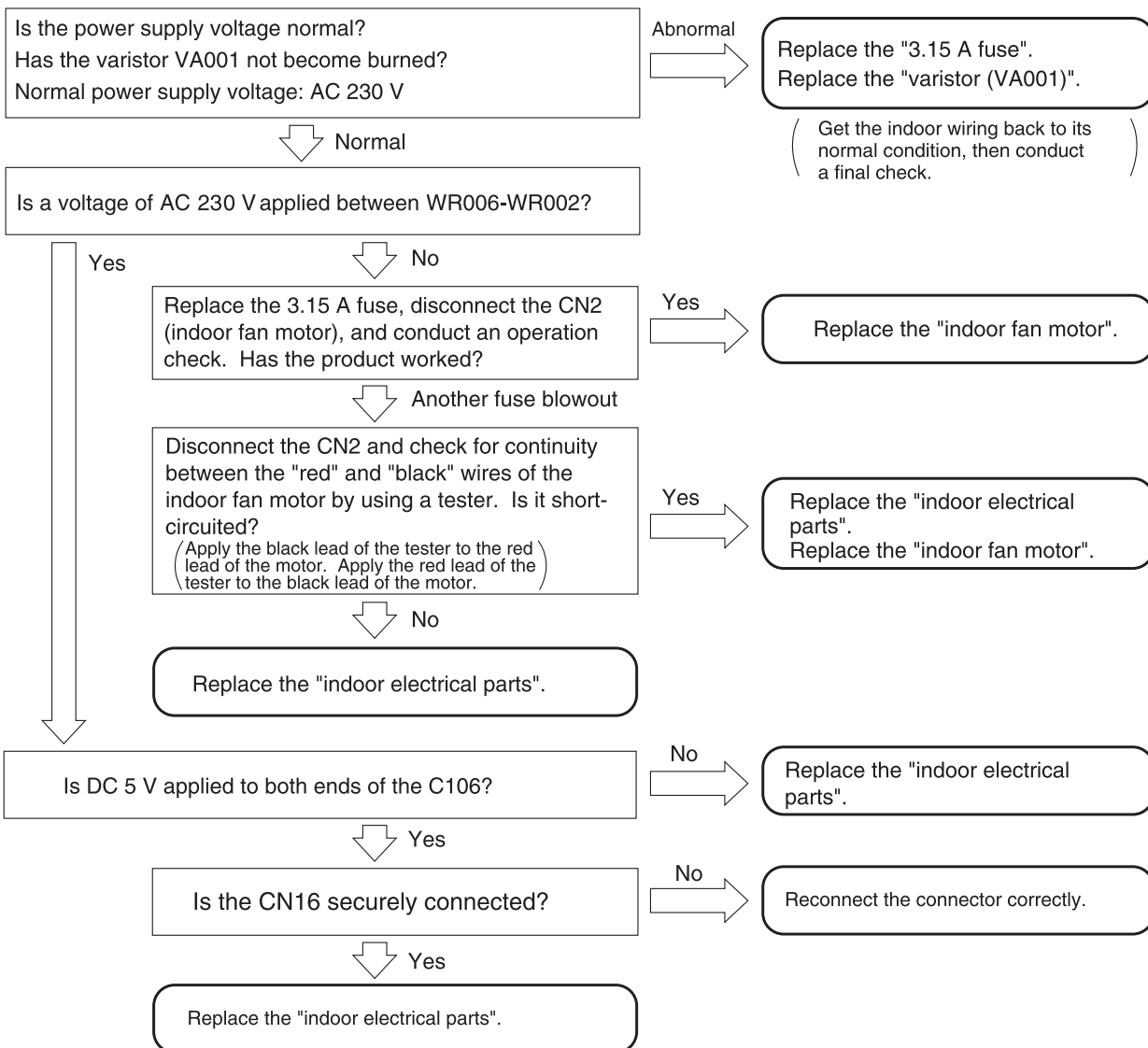

## 2.Failure phenomenon: The product will not receive a remote control signal.

[Situation ] The product does not receive a remote control signal. It is not very responsive.

(The product does run normally in response to the emergency operation switch.)

[Estimated failure locations ]

- Remote control failure, remote control low battery level, remote control poorly set
- Remote control light-receiving unit
- Connector loose, wire break
- Normal product (external factors: the remote control units for lighting equipment and other equipment, electrical noise, etc.)

[Cautions ]

- Even if the product is trouble-free, a factor coming from outside the product may hamper the reception of signals from the remote control unit.
- Batteries may decline in capacity at low temperatures. Old batteries decline particularly much in voltage in the morning and evening of winter, resulting in the poor arrival of remote control signals. Instruct your users to use new alkaline batteries.

[Diagnosis flow ]

Initiating troubleshooting

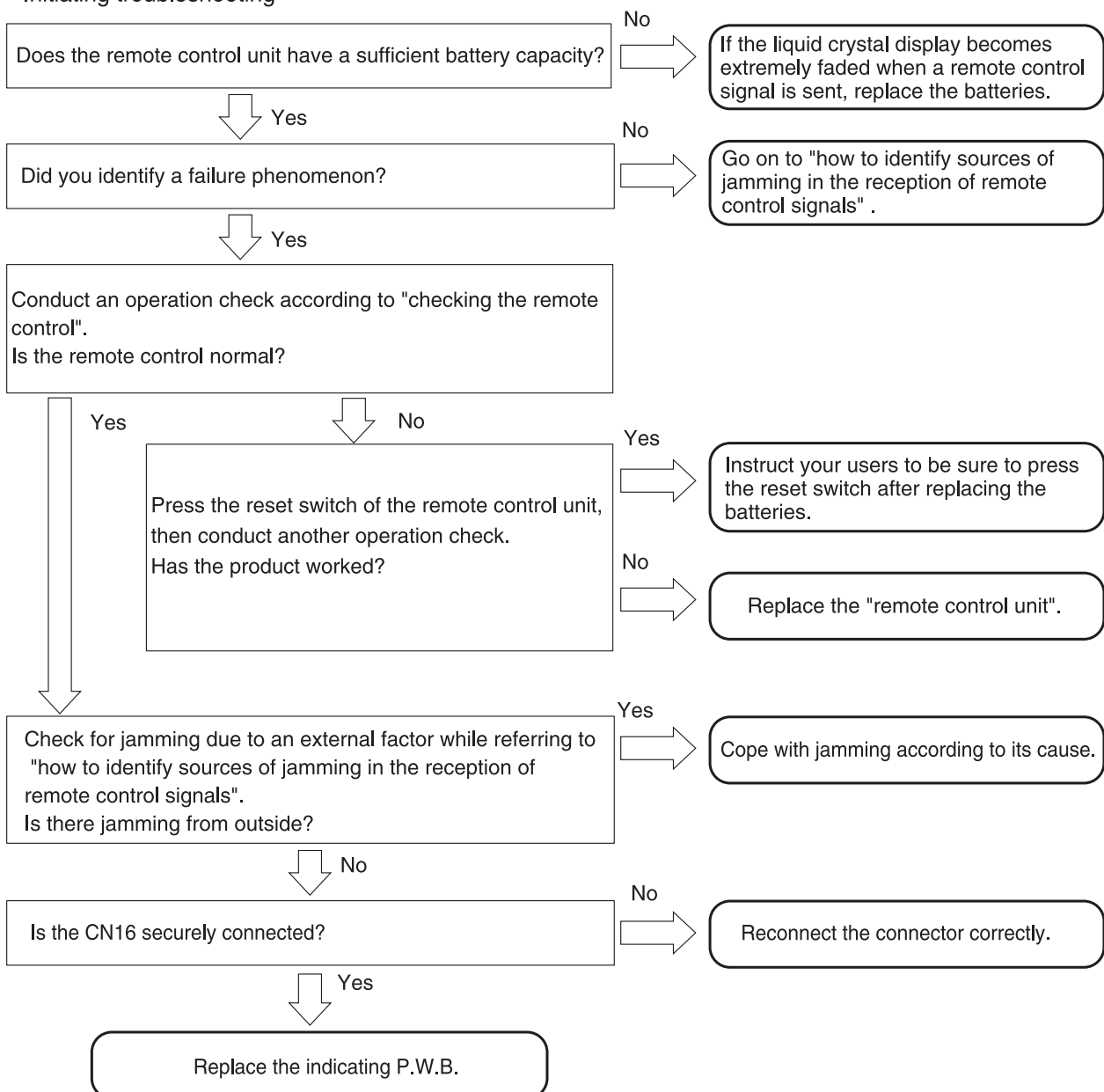

[Cautions in replacing the indicating P.W.B] Be sure to replace the indicating P.W.B. components.

## How to identify sources of jamming in the reception of remote control signals

[ Situation ] The product may become poorly responsive to remote control signals due to external factors even though the product itself is trouble-free.

[ Estimating sources of jamming ] Identify the installation status of the air-conditioner and the indoor and outdoor environments to identify possible causes of the jamming.

- Indoor lighting equipment (quantity, type, location)
- Remote control units of other electrical products and equipment
- Is the grounding for the air-conditioner shared with other equipment?
- Are the surroundings of the air-conditioner clear of wireless antenna?
- Is the remote control light-receiving unit protected from direct sunlight?

[ Checking and actions ]

|   |   |
|---|---|
| <p>Effects of lighting equipment (fluorescent lamps)</p>      | <p><u>Checking points</u></p> <ul style="list-style-type: none"> <li>· Turn on and off the lighting equipment and check for its effects on the reception of remote control signals.</li> <li>· When cold, the fluorescent lamp tends to emit infrared rays with wavelengths close to those used in remote control.</li> </ul> <p>If you cannot detect the phenomenon about which your user is complaining at the time of your visit, such as "the product sometimes fails to receive remote control signals" and "the product fails to receive remote control signals in the morning alone", then turn off the lighting for about 20-30 minutes and wait for the fluorescent lamps to cool down before conducting another check.</p> <p>There are even cases where the product fails to receive remote control signals for 1 to 2 minutes only after the lighting equipment is turned on.</p> <ul style="list-style-type: none"> <li>· The noise status may vary with the dimming of the lighting equipment. In the case of lighting equipment with a dimmer, therefore, conduct a check with all the light intensities.</li> <li>· If the lighting equipment is the source of the jamming, the remote control light-receiving unit output usually shows a noise waveform as shown in the right-hand figure. In the case of slight jamming, this kind of waveform will not cause practical problems. However, intense degrees of jamming will disable the reception of remote control signals.</li> <li>· When the fluorescent lamp is old and is flickering, it may cause disorders in the reception of remote control signals.</li> </ul> <p><u>Actions proposed</u></p> <ol style="list-style-type: none"> <li>1. Make it hard for light of the lighting equipment to enter the remote control light-receiving unit. <ul style="list-style-type: none"> <li>· Separate the lighting equipment from the indoor unit.</li> <li>· Raise the lighting equipment.</li> <li>· Cover the upper half of the light-receiving panel from its rear side with aluminum tape or black vinyl tape.</li> </ul> <p>( This will also affect the reception of remote control signals. Therefore, set the range to be covered with tape to a range that is problem-free in practice, while checking the reception status. )</p> </li> <li>2. Add an interference filter to the front panel of the remote control light-receiving unit. <ul style="list-style-type: none"> <li>※ Lighting equipment that produces strong jamming exists although rarely.</li> <li>Some problems may therefore be unsolvable by managing the air-conditioner side alone.</li> </ul> </li> </ol> |
| <p>Effects of the remote control units of other equipment</p> | <p><u>Checking points</u></p> <ul style="list-style-type: none"> <li>· If, on the remote control unit of a TV or audio equipment, its sound volume key or something similar is left pressed, infrared signals become continuously sent, thereby jamming the reception of remote control signals.</li> <li>· Check how the remote control unit and related components are stored, thereby checking if there is any possibility that a button may be inadvertently left pressed on the remote control unit of other equipment.</li> </ul> <p><u>Actions proposed</u></p> <p>If there is any such possibility, give explanations to your users to that effect and instruct them to exercise caution.</p>   |

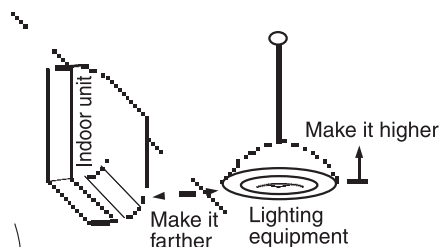
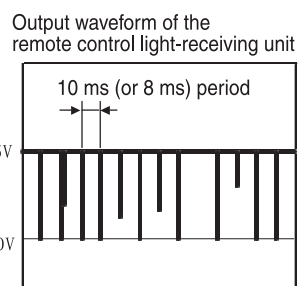

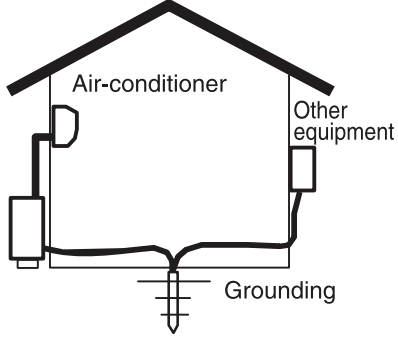
|   |  |
|---|--|
| <p>Effects of other electrical products</p> | <p><u>Checking points</u></p> <ul style="list-style-type: none"> <li>· Check the effects of light and power noises coming from other electrical products.</li> <li>· Turn on and off the electrical products, turn off the power and turn on the power, and check their effects on the reception of remote control signals.</li> <li>· For products whose operating states change, check the effects of each state.</li> </ul> <p><u>Actions proposed</u></p> <ul style="list-style-type: none"> <li>· Change the location relationship between the air-conditioner and the target products.</li> <li>· Use a different wall outlet for the target products.</li> </ul>  |
| <p>Sharing a grounding</p>                  | <p><u>Checking points</u></p> <ul style="list-style-type: none"> <li>· Check for effects of electrical noises coming into the air-conditioner through grounding wires.</li> <li>· Check if the grounding works is for the air-conditioner alone or shared with other equipment. If there is any equipment that shares it, turn on and off that equipment and detach and reattach the power plugs and examine their effects on the reception of remote control signals.</li> </ul> <p><u>Actions proposed</u></p> <ul style="list-style-type: none"> <li>· Establish an independent grounding for the air-conditioner.</li> </ul>  |
| <p>Effects of radio waves</p>               | <p><u>Checking points</u></p> <ul style="list-style-type: none"> <li>· Using a wireless transmitter near the air-conditioner may affect the reception of remote control signals.</li> <li>· Have your users try sending signals with a wireless transmitter and examine their effects on the reception of remote control signals.</li> </ul> <p><u>Actions proposed</u></p> <ul style="list-style-type: none"> <li>· Add a ferrite core to the power cord and F cable.</li> <li>· Add a ferrite core to the internal wiring of the indoor unit.</li> <li>· Move the wireless antenna.</li> </ul>   |
| <p>Effects of direct sunlight</p>           | <p><u>Checking points</u></p> <ul style="list-style-type: none"> <li>· Direct sunlight and other intense light make the remote control light-receiving unit less sensitive.</li> <li>· Check for any time zone where the remote control light-receiving unit of the indoor unit is affected by direct sunlight depending on the location of the sun and mirror reflection.</li> </ul> <p><u>Actions proposed</u></p> <ul style="list-style-type: none"> <li>· Block the sunlight to protect against direct sunlight.</li> </ul>  |

### 3. Failure phenomenon: The compressor will not run.

[ Situation ] The compressor will not run (the same state as the thermometer turned off), the product receives remote control signals normally. The self-diagnosis lamp (LD301) of the outdoor unit blinks once or becomes turned off.

[ Estimated failure locations ] · Room temperature thermistor, heat exchanger thermistor  
· Microcomputer peripheral circuit

[ Diagnosis flow ]  
Initiating troubleshooting

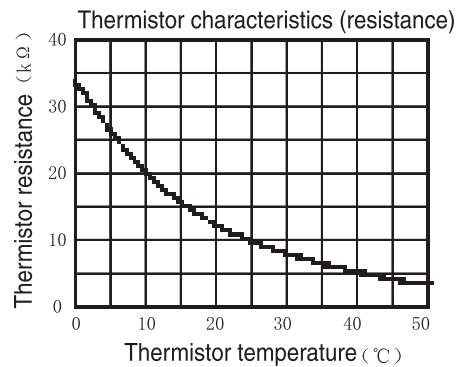
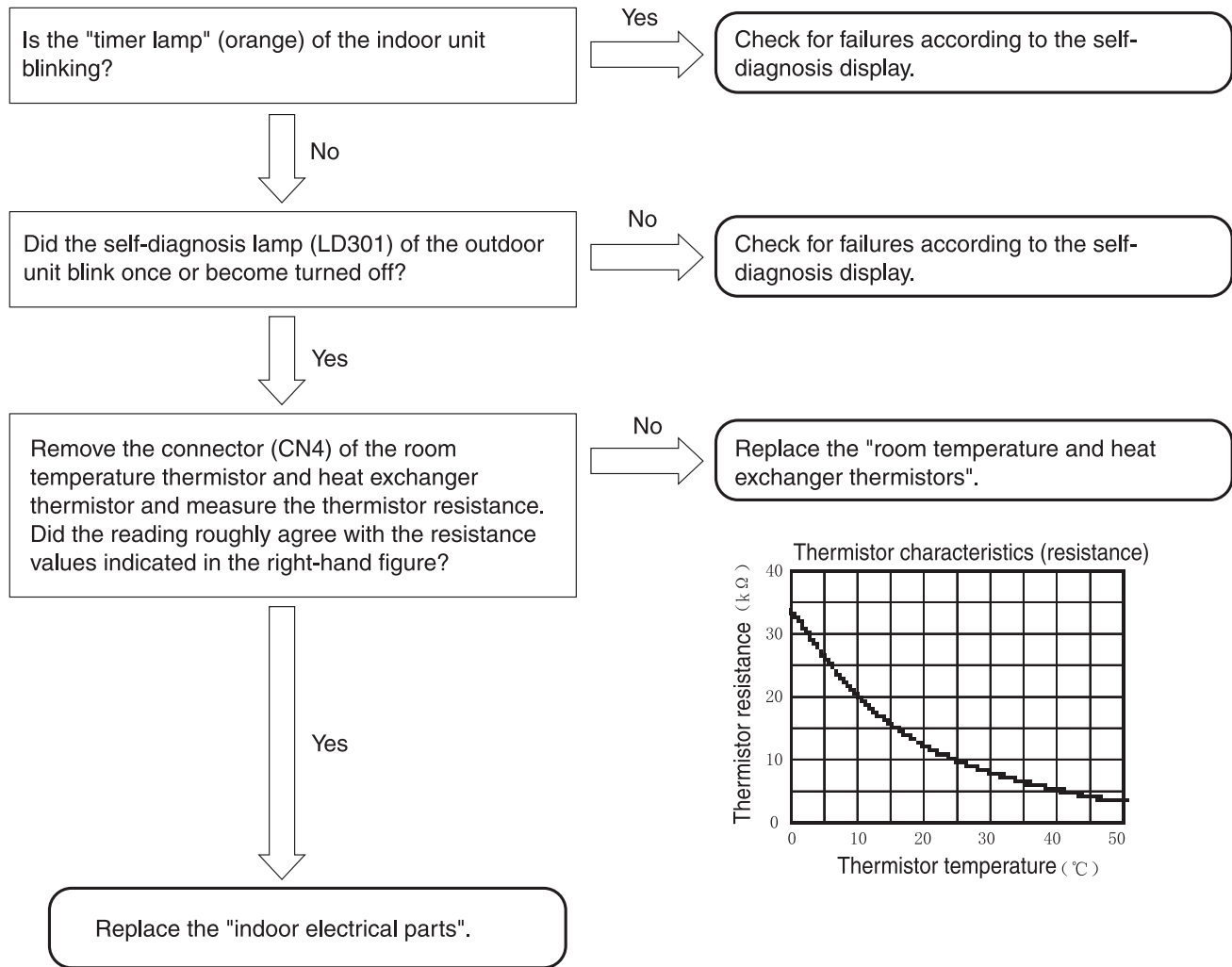



#### 4. Failure phenomenon: The fan motor will not stop.

[Situation ] I have conducted the stop operation on the product by remote control, but the indoor fan motor will not stop.  
(It stopped about 10 minutes later.)

[Estimated failure locations ]

- Indoor fan motor
- Fan motor drive circuit

[Diagnosis flow ]

Initiating troubleshooting

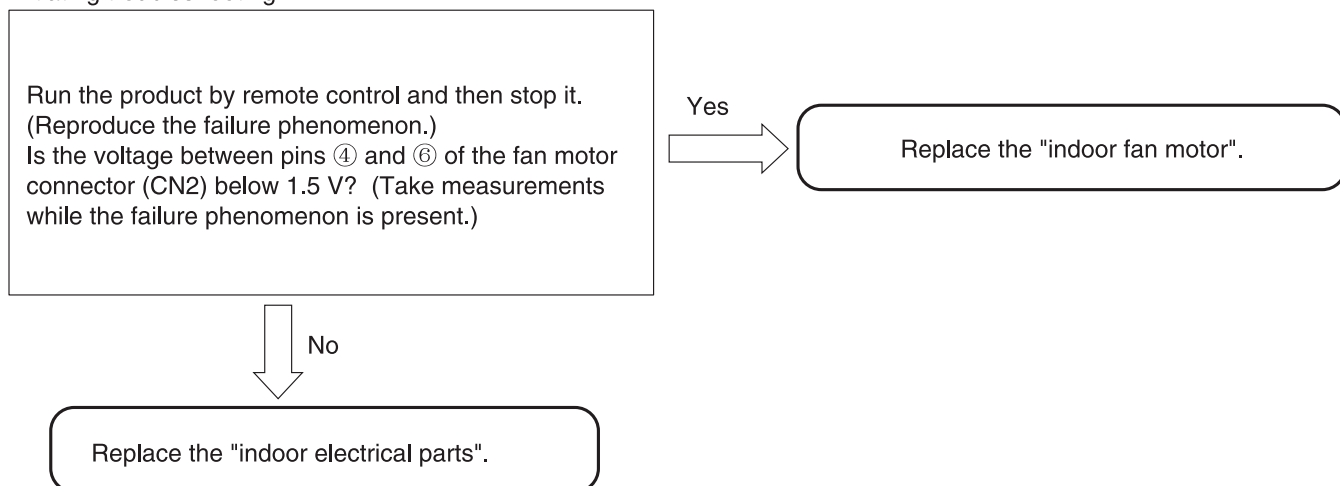

## 5. Timer lamp blinking: blinking once

[Situation] The timer lamp blinks one time and the product will not operate.  
(This is not a sign of a breakdown.)

[Estimated failure locations] · Reversing valve defective.  
· The refrigerating cycle block gas leak.

## 6. Timer lamp blinking: blinking twice

[Situation] The product is giving a display to indicate that it is performing forcible cooling.  
(This is not a sign of a breakdown.)

## 7. Timer lamp blinking: blinking three times

[Situation] The timer lamp blinks three times and the product will not operate.

[Estimated failure locations] · Meltdown of the terminal board temperature fuse (the terminal board poorly inserted into the F cable)  
· Outdoor communication circuit out of order

[Cautions] · If a terminal board is replaced to counter the meltdown of the terminal board temperature fuse, ensure that the F cable to be inserted into the terminal board has the appropriate dimension for peeling the insulation sheathing and that the insertion region is unbent before inserting it into the terminal board securely.

[Diagnosis flow]

Initiating troubleshooting

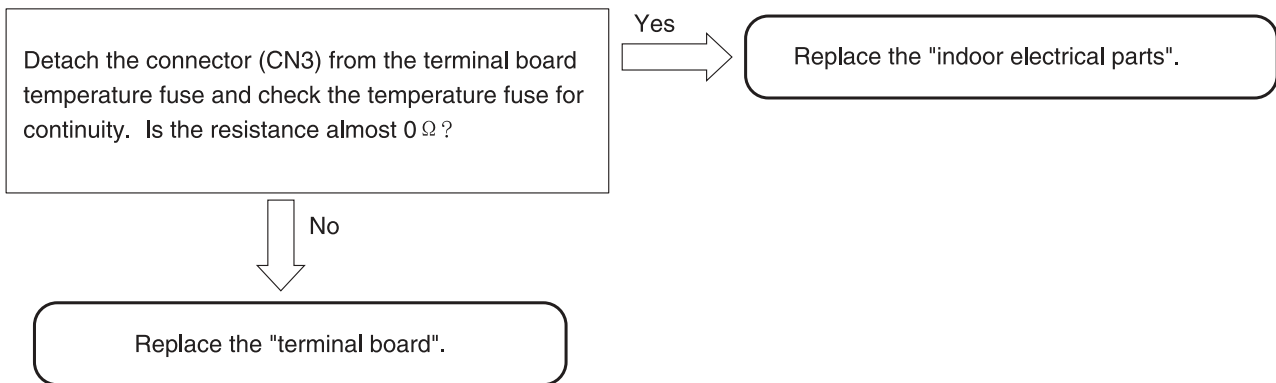

## 8. Timer lamp blinking: blinking four times

[Situation] The timer lamp blinks four times and the product will not operate.

[Estimated failure locations] · Outdoor unit error.  
· Please confirm the times of the LD301 blinking, and then see the outdoor selfcheck table.

## 9. Timer lamp blinking: blinking 9 times

[Situation] The timer lamp blinks 9 times and the product will not run.

[Estimated failure location] • Loose connector, wire break, or short-circuit in the room temperature thermistor, heat exchanger thermistor.

[Cautions] • Starting the product by remote control will initiate failure detection.  
(Merely turning on the power will not activate the failure detection function.)

[Diagnosis flow]

Initiating troubleshooting

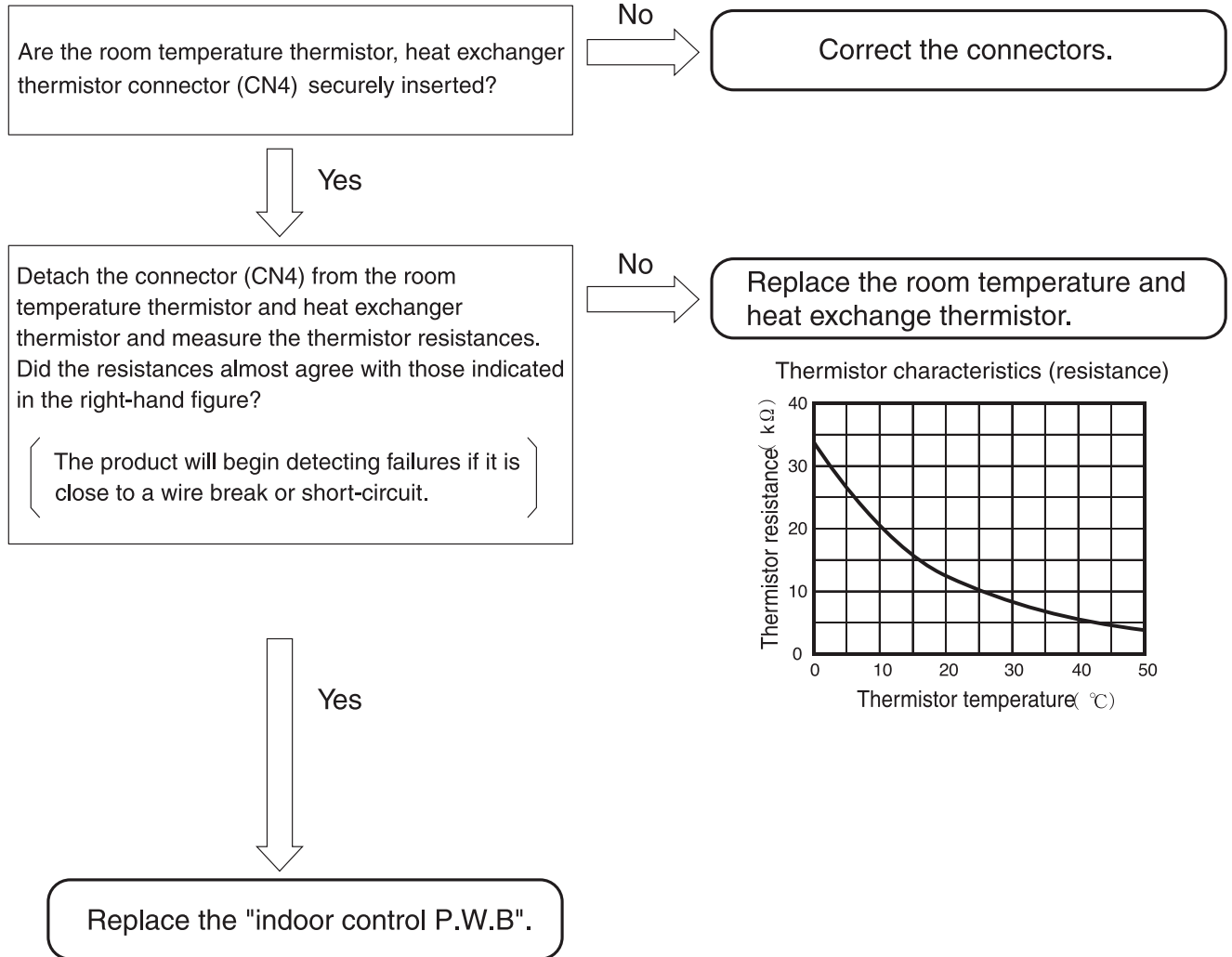

## 10. Timer lamp blinking: blinking 10 times

[Situation] The timer lamp blinks 10 times and the product will not run.

- [Estimated failure locations]
- Loose connector or wire break in the indoor fan motor
  - Indoor fan motor mechanically locked
  - Indoor fan motor
  - Indoor fan motor drive circuit

[Diagnosis flow]

Initiating troubleshooting

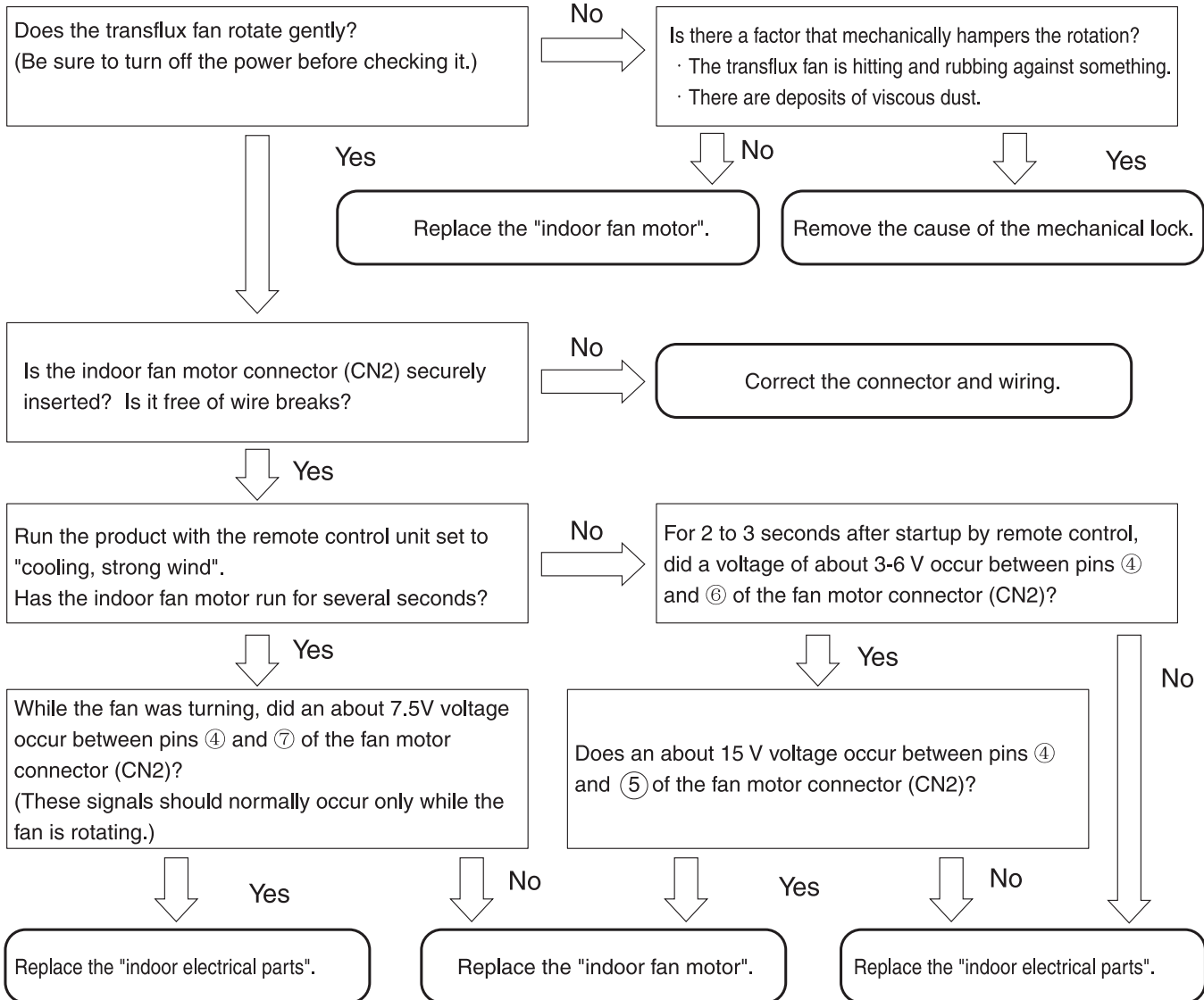

### 11. Timer lamp blinking: blinking 12 times

[Situation] The timer blinks 12 times and the product will not run.

[Estimated failure locations] • Erroneous connection in the indoor-outdoor connection line (F cable)  
• Wire break or poor insertion of the indoor-outdoor connection line (F cable)  
• Electrical parts in the outdoor unit (communication circuit, power circuit error)  
• Communication error due to noise in other home electronics  
※This does not constitute a failure in the air-conditioner

[Cautions] • When lines 1 and 2 of F cable are erroneously connected (crossed), the product may not enter self-diagnosis display mode. If the self-diagnosis memory stores data about "timer lamp blinked 12 times", then, just in case, check if the F cable is not erroneously connected.

#### [Diagnosis flow]

Initiating troubleshooting

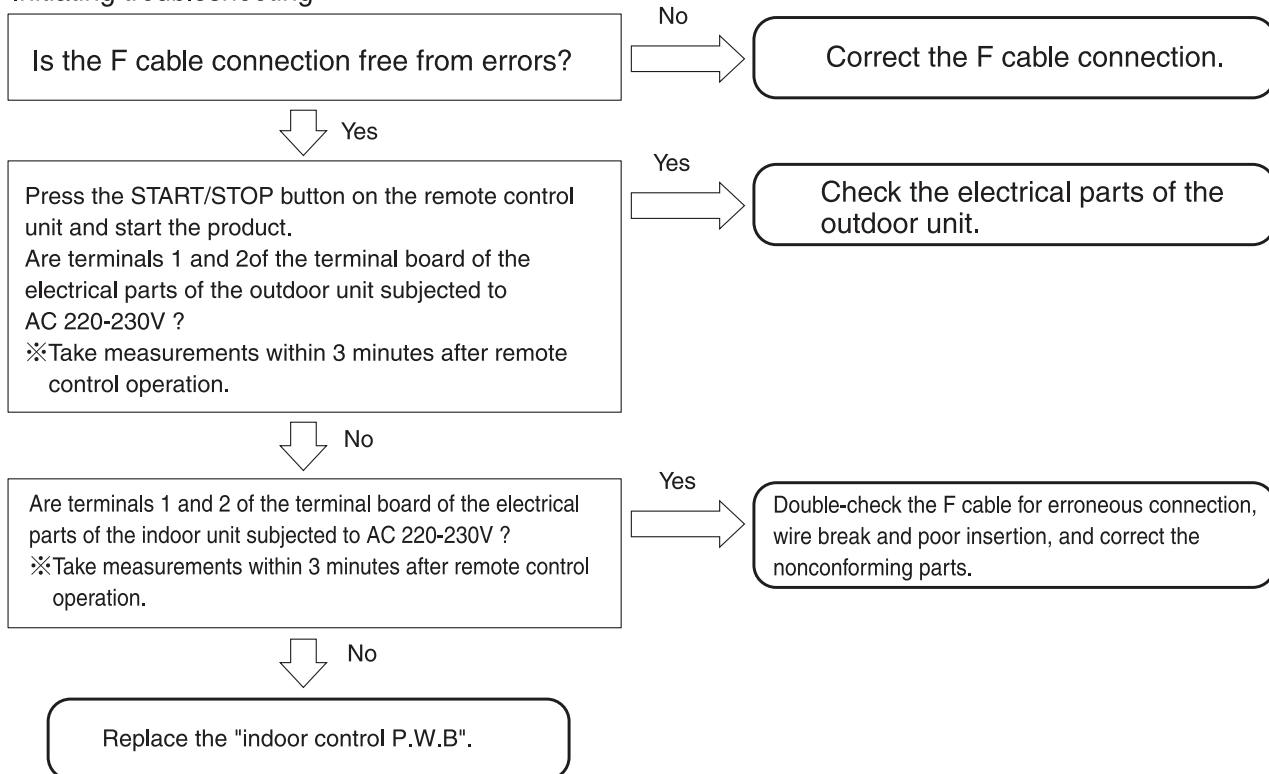

### 12. Timer lamp blinking: blinking 13 times

[Situation] The timer lamp blinks 13 times and the product will not run.

[Estimated failure location] • EEPROM, microcomputer

[Diagnosis flow]

Replace the "indoor control P.W.B".

### 13. Timer lamp blinking: blinking 21 times

[Situation] The timer lamp blinks 21 times and the product will not run.

[Estimated failure location] • other machine cause

[Diagnosis flow]

Check "interference sources".

**PART LIST AND DIAGRAM**

INDOOR UNIT

MODEL RAK-DJ24PHAA

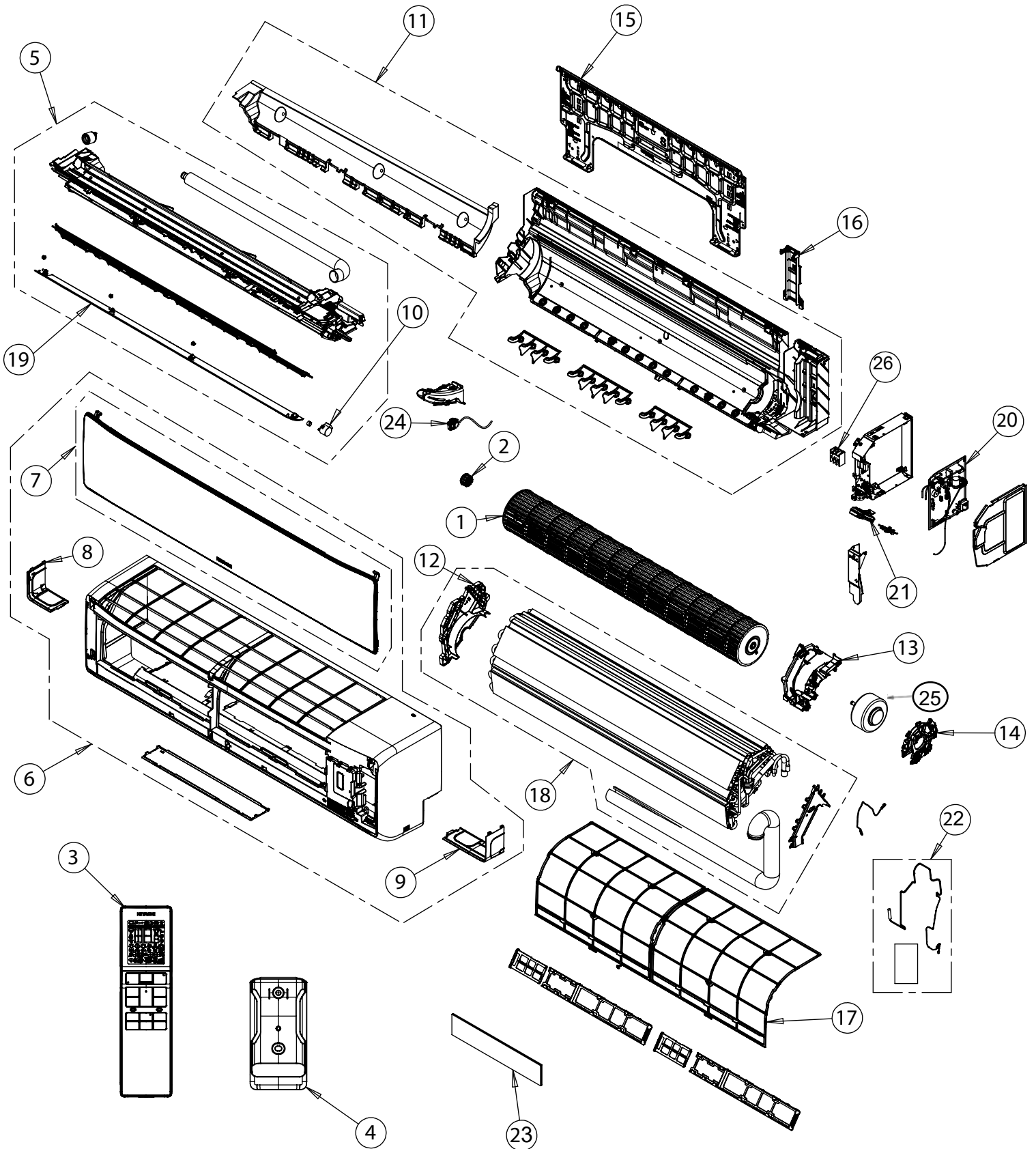

MODEL: RAK-DJ24PHAA

| NO. | PART NO.      |     | QTY/UNIT | PARTS NAME            |
|-----|---------------|-----|----------|-----------------------|
| 1   | PMK-VJ60PHAE  | R11 | 1        | TANGENTIAL FAN        |
| 2   | PMRAS-25YH4   | 908 | 1        | P-BEARING ASSY        |
| 3   | PMK-DJ09PHAA  | R05 | 1        | REMOTE CONTROL        |
| 4   | PMK-DJ09PHAA  | R06 | 1        | REMOTE CONTROL HOLDER |
| 5   | PMK-DJ24PHAA  | R02 | 1        | DRAINPAN ASSY         |
| 6   | PMK-DJ24PHAA  | R04 | 1        | FRONT COVER ASSY      |
| 7   | PMK-DJ70PCAT  | R05 | 1        | FRONT PANEL           |
| 8   | PMK-DJ10PCASV | R17 | 1        | S-COVER-L             |
| 9   | PMK-VH24PHASV | R03 | 1        | S-COVER-R             |
| 10  | PMK-DJ10PCASV | R07 | 1        | AUTO SWEEP MOTOR      |
| 11  | PMK-DJ24PHAA  | R03 | 1        | CABINET               |
| 12  | PMK-DJ60PHAE  | R05 | 1        | BEARING COVER         |
| 13  | PMK-VJ60PHAE  | R08 | 1        | FM-BASE-L             |
| 14  | PMK-DJ10PCASV | R22 | 1        | FM-BASE-R             |
| 15  | PMK-DJ18PCASV | R10 | 1        | MOUNTING PLATE        |
| 16  | PMK-DJ10PCASV | R16 | 1        | PIPE SUPPORT          |
| 17  | PMK-VJ60PHAE  | R09 | 1        | AIR FILTER            |
| 18  | PMK-VJ70PHAE  | R02 | 1        | CYCLE ASSY            |
| 19  | PMK-DJ24PHAA  | R05 | 1        | H-DEFLECTOR           |
| 20  | PMK-DJ24PHAA  | R01 | 1        | PWB-MAIN              |
| 21  | PMK-DJ50PCAT  | R10 | 1        | PWB RECEIVER          |
| 22  | PMK-DJ09PHAA  | R07 | 1        | THERMISTOR            |
| 23  | SPX-CFH22AC25 |     | 1        | ACL-FILTER            |
| 24  | PMK-DJ60PHAE  | R04 | 1        | SENSOR ASSEMBLY       |
| 25  | PMK-DJ09PHAA  | R03 | 1        | FAN MOTOR             |
| 26  | PMRAK-50PPD   | R07 | 1        | TERMINAL BOARD (3P)   |
| 27  |               |     |          |                       |
| 28  |               |     |          |                       |
| 29  |               |     |          |                       |

# HITACHI

**RAK-DJ24PHAA**

**PM NO. 0854E**

Printed in Malaysia

**SPECIFICATIONS AND PARTS ARE SUBJECT TO CHANGE FOR IMPROVEMENT**

---

**Johnson Control-Hitachi Air Conditioning Malaysia Sdn. Bhd.**

---

**AUGUST 2024**